



UMAJIRUSHI
日本馬印
since 1896



www.uma-jirushi.com



 UMAJIRUSHI



UMAJIRUSHI
日本馬印

CATALOG

One-stop Board Solution Provider

Made in Japan



umajirushi



umajirushi 日本馬印



www.uma-jirushi.com





UMAJIRUSHI was established in year 1896, it is a premium brand of presentation and writing products in Japan.

UMAJIRUSHI believes that to deliver a message to client efficiently, it is important to use an appropriate product. Therefore, UMAJIRUSHI has designed over 100 models of writing products to fit in different environments, purposes, venues and aging groups.

With over a decade of experience in design and manufacturing of writing products, UMAJIRUSHI has attained the top grading of their products in terms of Quality, Safety, Functionality, Flexibility, Appearance and Environmental-Friendly in the industry.

UMAJIRUSHI insists to manufacture in Japan to ensure the best quality control on design, material and product safety, UMAJIRUSHI promised to always deliver the BEST to the customer.

We made, we delivered and we conquered a satisfactory smile on every face!

馬印成立於1896年，是日本知名的展示和書寫產品的生產商，歷史悠久。

馬印一直相信，只有選取正確的產品，才能有效地傳遞所需表達的訊息給客戶。為此馬印設計了過百款的展示和書寫產品以切合不同的環境、目的、場合和年齡群去使用。

憑藉超過一個世紀所累積下來的產品開發經驗，馬印所有的產品無論在外觀、品質、用料、靈活性及安全性在業界內都得到一份非常肯定的保證，為了保持產品的高質素，馬印至今仍保持在日本本地生產和組裝，這一份的堅持，同時是給予客戶信心保證的承諾。

我們衷心將這份用心製造的產品介紹給所有親愛的客戶，讓你們用得開心、用得滿意、用得放心。



Brand Name: UMA-JIRUSHI
Head Office: Nakagawa Ward, Nagoya, Japan
Manufacturing Plant: Komaki-shi, Nagoya, Japan
Established Year: 1896
Quality Assurance: ISO 9001
Aichi Quality Brand
GPN (Green Purchasing Network)

品牌名稱: 日本馬印
總公司: 日本名古屋中川區
工場: 日本名古屋小牧市
創立年份: 1896
品質認證: ISO 9001
愛知縣品牌企業
環保購物聯網認可

General Agent: Kenton Investment Limited
Address: 1912, Block A, New Trade Plaza,
6 On Ping Street, Shatin, Hong Kong
Tel: (852) 3586 0144
Fax: (852) 3586 0145
Email: info@kentonhk.com
Website: www.uma-jirushi.com
Facebook: UMAJIRUSHI 日本馬印
IG: UMAJIRUSHI

總代理: 東興行投資有限公司
地址: 香港沙田安平街6號新貿中心A座1912室
電話: (852) 3586 0144
傳真: (852) 3586 0145
電郵: info@kentonhk.com
網址: www.uma-jirushi.com
Facebook: UMAJIRUSHI 日本馬印
IG: UMAJIRUSHI





Chalk
粉筆



UM Chalk
投影板專用粉筆



Gel Chalk
多用途粉筆



Whiteboard Marker
白板筆



Hook
掛鉤



Pin
圖釘



Pinless
無需圖釘



Magnet
磁石



Projector Screen
投影表面



Loop Face
絨布面



GPN Products
符合環保購物法商品



Poster Panel
圖架開關



Poster Panel
圖架開關



Attention
注意事項



Laser Print
適用於激光劃線

Office Whiteboard

- MH Series 2
- AX Series 4
- NV Series 5
- Schedule Planner 6

Board Printing

- Laser Print Service 7

Mobile Whiteboard

- MHTN Series 8
- MHTDN Series 9
- PVV Series / UD Series 10
- Transparent Board 12

Projection Whiteboard

- Non-Reflective Whiteboard 14
- Standard Type 15
- Seamless Type 16
- Interactive Solution 17

Whiteboard Sheet

- Adhesive 18
- Projector Screen 19

Notice Board

- One-way Notice Board 20
- Two-way Magnetic Notice Board 21
- Display Panel 22
- Multi Purpose Partition Board 23

Display Series

- Wood Color Frame Series 24
- Blackboard 25
- Display Case 26
- Poster Frame 27

School Series

- Magnetic Greenboard 28
- Mobile Large Board 29
- Mega Board 30
- Vertical Sliding Board 31
- Horizontal Sliding Board 32
- Board Renewal 33

Color Series

- Small Colorboard 35
- Color Combination 36

Kids Series

- Mobile Whiteboard 38
- Transparent Board 39

Accessories

- High Density Dustless Chalk 40
- School Chalk 41
- POP Gel Chalk / Glassboard Marker 42
- Whiteboard Marker and Eraser 43
- Magnetic Products 44

Customized Case

- Vertical Whiteboard Panels with hidden door 45
- Free Standing Whiteboard Wall / Large Seamless Projection Whiteboard 46
- Whiteboard Wall / Vertical Sliding Board Combo 47
- Curved Whiteboard / Whiteboard Cabinet 48

A 辦公室白板

- MH 搪瓷系列
- AX 高級搪瓷系列
- 輕巧磁性白板
- 行事計劃表

B 板面印刷

- 激光劃線服務

C 活動白板

- 單面活動白板
- 雙面活動白板
- 可連結白板 / UD 系列
- 透明板

D 投影白板

- 投影白板
- 標準尺寸
- 無縫系列
- 互動投影方案

E 白板貼

- 黏貼式
- 投影白板貼

F 告示板

- 告示板
- 兩用告示板
- 連結展示板
- 多用途間隔牆板

G 展示系列

- 木紋邊框系列
- 黑板
- 展示箱
- 海報架

H 學校系列

- 磁性綠板
- 活動式大型板
- 超大型板
- 上下升降板
- 左右活動板
- 板面翻新

I 彩色系列

- 彩色小板
- 配色組合

J 幼兒系列

- 活動白板
- 透明板

K 配件

- 高密度無塵粉筆
- 學校粉筆
- 多用途粉筆 / 玻璃白板筆
- 白板筆及板刷
- 磁性產品

L 訂製案例

- 併合式白板牆連暗門
- 自立式白板牆 / 大型無縫投影白板
- 白板牆 / 上下升降組合板
- 曲面白板 / 白板櫃門

MH series

Porcelain Enamel Magnetic Whiteboard (Wall-mount) 搪瓷磁性白板 (掛牆式)

MH Series

UMAIRUSHI best selling enamel whiteboard
Flexible for Horizontal and Vertical Installation
Removable pen tray can be fixed on any side of the board

馬印最暢銷的搪瓷白板
產品可置橫或置直安裝
上鎖式筆盤可安裝在任何一邊的邊框上



MH48
W2410×H1210

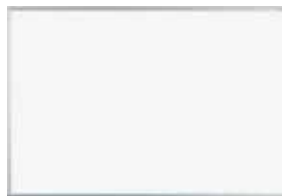

MH46
W1810×H1210

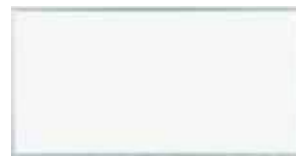

MH36
W1810×H910

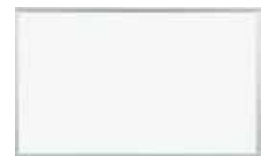

MH35
W1510×H910



MH34
W1210×H910



MH33
W910×H910



MH23
W910×H610



MH24
W1210×H610

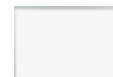

MH2
W610×H460





MH1
W460×H310

Features

- Extra Slim: board thickness in 6 mm
- Aluminum Alloy Frame thickness is 18mm
- Hustle Free from Humidity: there is a 6mm space reserved between the wall and whiteboard backing, no direct contact with the wall surface to avoid unexpected effects on the board.
- The board surface obtains the result of 5.5-6.5 under the Mohs Hardness Test, free from scratch
- Assembled by machine to ensure the smoothness of the board surface, you can write and erase the writings easily
- Magnetic surface, compatible with all magnetic products.

特點

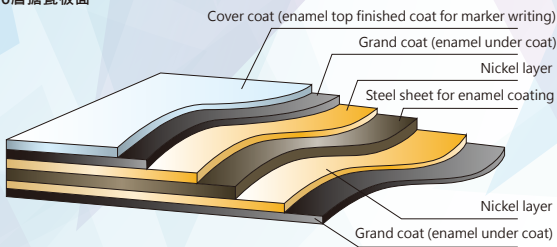
- 纖巧設計: 白板厚度只有 6mm
- 流線型鋁合金邊框厚度 18mm
- 不易受潮: 安裝後 板背與牆壁留有 6mm 的距離, 避免接觸牆壁表面, 影響產品的書寫質素
- 摩氏硬度 5.5 搪瓷板材, 抗刮度強, 更加耐用
- 板面以機械壓制而成, 保證板面受力均勻、平滑, 且不易變形, 而且易寫易擦
- 磁性板面, 可配合其他磁性配件使用

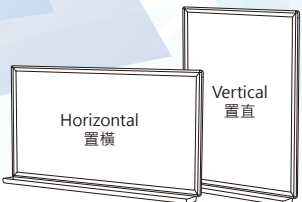
<p>6 Layers board structure 6層搪瓷版面</p> 	<p>Round-safety corner design 安全圓角設計</p> 	 <p>Horizontal 置橫 Vertical 置直</p> <p>Flexible for Horizontal and Vertical Installation. 產品可置橫或置直安裝。</p>
---	--	--

For MH23 or above MH23 或以上

<p>Pen Tray Installation 安裝筆盤的方法</p>  <p>Place the lock in the pen tray hole, twist to lock the pen tray. 將鎖放在筆盤的鎖孔上，輕輕一扭便可鎖緊筆盤。</p>	<p>Accessories 附加產品</p> <table border="0"> <tr> <td data-bbox="718 582 893 784"> <p>MH33 or above (W910 x H910)</p> <ul style="list-style-type: none"> - Eraser (large), 1pc - Markers, 2 pcs (Black/Red, one each) - Magnet, 2pcs <p>MH33或以上 (W910 x H910)</p> <ul style="list-style-type: none"> - 白板擦 (大) x 1個 - 白板筆 x 2支 (黑色/紅色) - 磁石 x 2粒 </td> <td data-bbox="1085 582 1452 784"> <p>MH24 or below (W1210 x H610)</p> <ul style="list-style-type: none"> - Eraser (small), 1pc - Markers, 1 pc (Black) - Magnet, 2pcs <p>MH24或以下 (W1210 x H610)</p> <ul style="list-style-type: none"> - 白板擦 (小) x 1個 - 白板筆 x 1支 (黑色) - 磁石 x 2粒 </td> </tr> </table>	<p>MH33 or above (W910 x H910)</p> <ul style="list-style-type: none"> - Eraser (large), 1pc - Markers, 2 pcs (Black/Red, one each) - Magnet, 2pcs <p>MH33或以上 (W910 x H910)</p> <ul style="list-style-type: none"> - 白板擦 (大) x 1個 - 白板筆 x 2支 (黑色/紅色) - 磁石 x 2粒 	<p>MH24 or below (W1210 x H610)</p> <ul style="list-style-type: none"> - Eraser (small), 1pc - Markers, 1 pc (Black) - Magnet, 2pcs <p>MH24或以下 (W1210 x H610)</p> <ul style="list-style-type: none"> - 白板擦 (小) x 1個 - 白板筆 x 1支 (黑色) - 磁石 x 2粒
<p>MH33 or above (W910 x H910)</p> <ul style="list-style-type: none"> - Eraser (large), 1pc - Markers, 2 pcs (Black/Red, one each) - Magnet, 2pcs <p>MH33或以上 (W910 x H910)</p> <ul style="list-style-type: none"> - 白板擦 (大) x 1個 - 白板筆 x 2支 (黑色/紅色) - 磁石 x 2粒 	<p>MH24 or below (W1210 x H610)</p> <ul style="list-style-type: none"> - Eraser (small), 1pc - Markers, 1 pc (Black) - Magnet, 2pcs <p>MH24或以下 (W1210 x H610)</p> <ul style="list-style-type: none"> - 白板擦 (小) x 1個 - 白板筆 x 1支 (黑色) - 磁石 x 2粒 		

Standard Installation 標準安裝

2-in-1 Hanger 二合一掛鉤

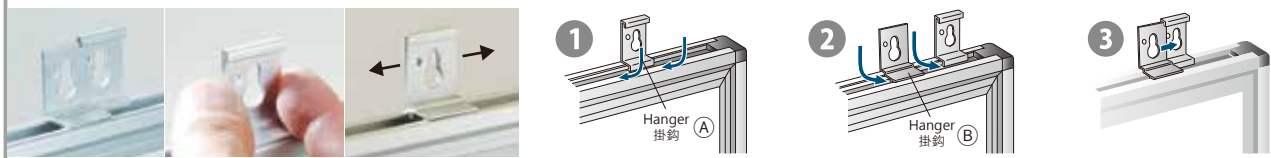

The hanger can move along the frame before confirm dwelling.
特製二合一掛鉤，安全易用，掛鉤可左右移動，方便安裝。

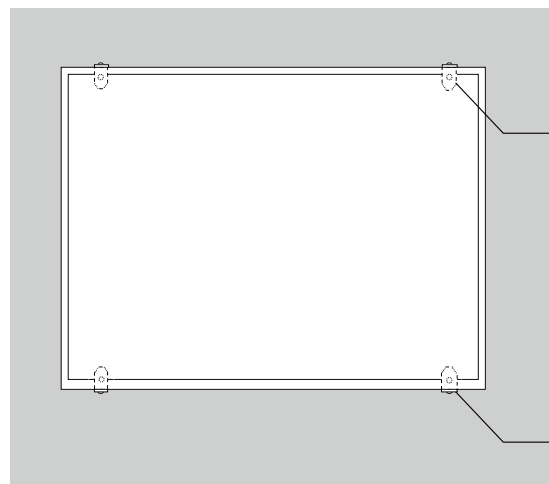
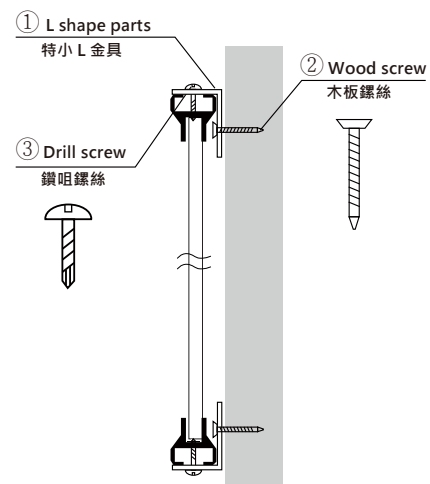

Concealed Installation 隱密式安裝

<p>Front 正面圖</p>  <p>① L shape parts 特小 L 金具</p>	<p>Side 側面圖</p>  <p>① L shape parts 特小 L 金具</p> <p>② Wood screw 木板螺絲</p> <p>③ Drill screw 鑽咀螺絲</p>
--	---

For MH2 or below MH2 或以下

<p>Frame 邊框</p> 	<p>Movable Hangers 活動掛鉤</p> 	<p>Pen Tray Installation 安裝筆盤的方法</p> 
--	--	--



Professional Porcelain Enamel Magnetic Whiteboard 專業級搪瓷磁性白板

AX Series

Professional Whiteboard Model

專業搪瓷白板

Wall-mount 掛牆式

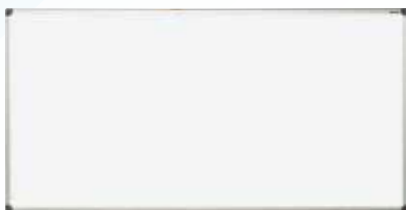

AX36N
W1810×H920



AX34N
W1210×H920



AX23N
W910×H620

Single-sided Mobile 單面活動式



AX36TN
W1903 x D570 x H1842



AX34TN
W1303 x D570 x H1842

Double-sided Mobile 雙面活動式



AX36TDN
W1924 x D570 x H1847

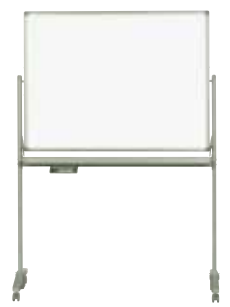

AX34TDN
W1324 x D570 x H1847

Features

- Board thickness in 6 mm
- Aluminum Alloy Frame thickness in 30mm
- Hustle Free from Humidity: there is a 5mm space reserved between the wall and whiteboard backing. No direct contact with the wall surface to avoid unexpected effects on the board
- The board surface obtains the result of 5.5-6.5 under the Mohs Hardness Test, free from scratch
- Assembled by machine to ensure the smoothness of the board surface, you can write and erase the writings easily
- Magnetic surface, compatible with all magnetic products

特點

- 白板厚度只有6mm
- 流線型鋁合金邊框厚度30mm
- 不易受潮: 安裝後板背與牆壁留有6mm的距離, 避免接觸牆壁表面, 影響產品的書寫質素
- 摩氏硬度5.5搪瓷板材, 抗刮度強, 更加耐用
- 板面以機械壓制而成, 保證板面受力均勻、平滑, 且不易變形, 而且易寫易擦
- 磁性板面, 可配合其他磁性配件使用

6 Layers board structure 6層搪瓷板面

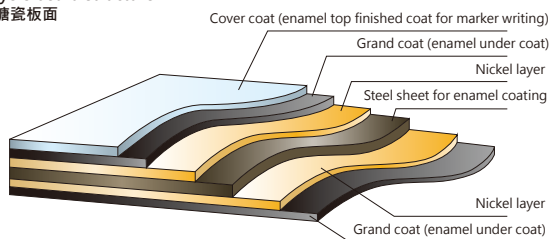

35mm Round-safety corner design 35毫米安全圓角設計



Standard or Concealed installation 外掛式或隱藏式安裝



Double-deck pen tray (for model AX34 and AX 36) 雙層筆盤 (適用於AX34及AX36型號)



Eco-friendly Light Weight Magnetic Whiteboard 環保輕巧型磁性白板

NV Series

Light Weight Magnetic Whiteboard
Suitable to install on the wall surface that cannot support heavy weight

輕巧磁性白板
適合安裝在非水泥牆的地方

Wall-mount 掛牆式

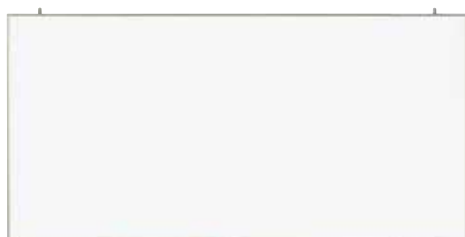

NV36
W1800×H900



NV34
W1200×H900

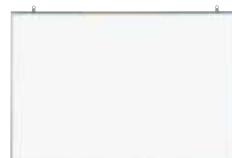

NV23
W900×H600



NV1
W450×H300



NV2
W600×H450

Features

- Ultra Slim: 12mm thickness only
- Light: One third of enamel whiteboard weight
- Flexible: Flexible for horizontal or vertical installation
- Magnetic: Magnetic surface, capable with all magnet products
- Eco-Friendly: Japan GREEN Purchase Network product
- Safety: Round corner design

特點

- 超薄: 板身厚度只有12毫米
- 超輕: 重量約為搪瓷白板三分之一
- 靈活: 板面可選擇置橫或置直安裝
- 磁性: 磁性板面, 可配合其他磁性配件使用
- 環保: 符合日本「GREEN 購入法」之環保商品
- 安全: 圓角鋁邊設計

Accessories 附加產品



(W900×H600) above
Whiteboard Marker
(Black), 1pc
Eraser, 1pc



(W600×H450) below
Whiteboard Marker
(Black), 1pc

Movable Hangers 活動掛鉤



Pen Tray Installation 安裝筆盤的方法

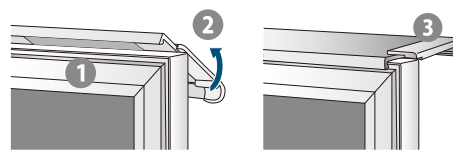

Schedule Planner 行事計劃表

Vertical Monthly Schedule Planner 直向式行事曆



MH36M

Model No. 型號	Size 尺寸 (mm)
MH23M	W910×H610
MH34M	W1210×H910
MH35M	W1510×H910
MH36M	W1810×H910

Suitable for schedule planning by project
適用於以【項目】為單位的進度管理

Horizontal Monthly Schedule Planner 橫向式行事曆



MH36Y

Model No. 型號	Size 尺寸 (mm)
MH23Y	W910×H610
MH34Y	W1210×H910
MH35Y	W1510×H910
MH36Y	W1810×H910

Suitable for schedule planning by date
適用於以【時間】為單位的進度管理

Create your own whiteboard 來稿製作白板



Double-sided Mobile Whiteboard
雙面活動白板

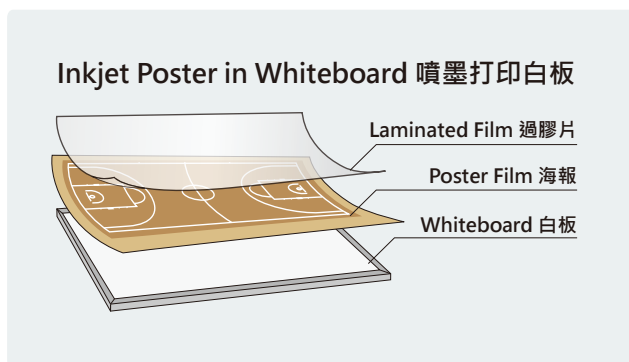

Inkjet Poster in Whiteboard 噴墨打印白板

Laminated Film 過膠片

Poster Film 海報

Whiteboard 白板

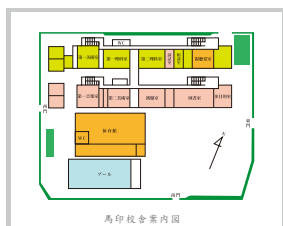

Floor Plan
建築平面圖

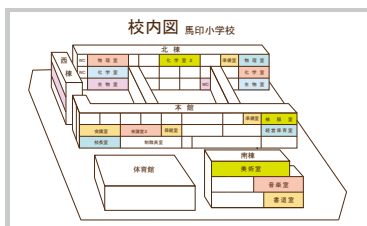

School Map
校園圖



Map
地圖

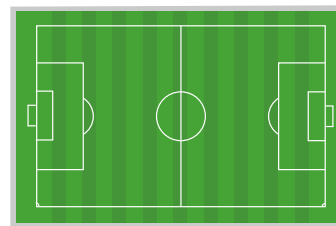

Soccer Strategy Map
足球策略圖

Board Printing 板面印刷



Laser Print Service 激光劃線服務

Present your printing precisely and permanently
Tailor-made according to your requirements

永久耐用 · 細緻精確
可按客戶需求訂製不同的式樣

Durable for lifetime - All printings will not be erased or faded away after long time usage
Precise - The printing works is controlled by computer to ensure all drawings are exactly the same as the source
Sharp - You can choose different thickness of the line, the finest is only 0.2mm

永久耐用 - 有別於膠貼線或油墨線的做法, 激光劃線能有效地避免因多次拭擦而令線條變得模糊或脫落, 永久耐用
細緻精確 - 電腦操作讓圖案/表格更加準確, 避免線條粗幼不一、深淺有別的問題
清晰美觀 - 激光劃線提供多種不同粗幼的線條, 最幼細可達至0.2mm, 人手劃線並不能做到

B

Laser Print 激光劃線服務

Enamel
搪瓷



Standard line in 0.4mm, can choose solid and dotted lines.
標準線條0.4毫米, 可選實線和虛線。

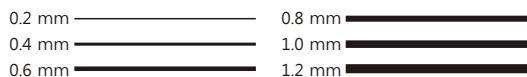

Paint Printing 塗漆服務

Enamel
搪瓷

Steel
鐵面

Greenboard
綠板

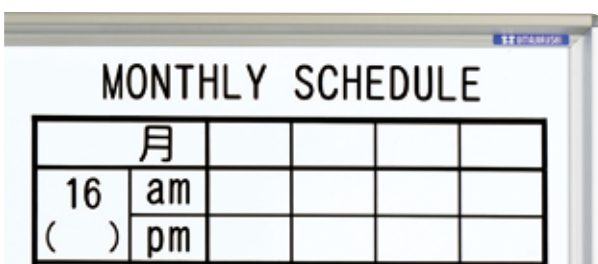

Standard line in 1mm.
標準線條1毫米。



STEP 1

Laser print color 激光劃線顏色

Whiteboard 白板

Dark grey (same as the enamel under coat color)
灰黑色 (搪瓷底層的原色)

STEP 1

Paint printing color 塗漆顏色

Whiteboard 白板

Greenboard 綠板



Black黑 Brown啡 Blue藍



White白 Yellow黃

STEP 2

Font Selection 字體選擇

01 細圓體

02 細黑體

03 明朝體/粗宋體

04 粗圓體

05 粗黑體

06 楷書體

月 行動予定表

月 行動予定表

月 行動予定表

月 行動予定表

月 行動予定表

月 行動予定表

STEP 3

Color Selection 顏色



01 Black 02 Dark Brown 03 Blue 04 White 05 Yellow 06 Orange 07 Red



08 Magenta 09 Salmon Pink 10 Sky Blue 11 Apple Green 12 Green 13 Grey 14 Dark Grey



Double-line Board (English) 雙線板 (英文科)

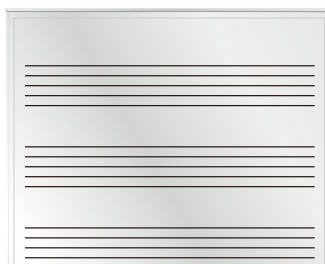

Music Board 五線板 (音樂科)



Homework Assignment Table 家課日誌

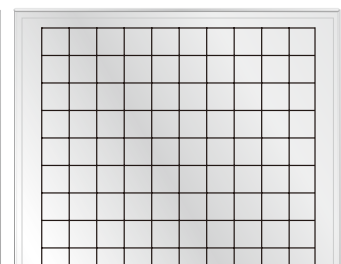

Table with Grid (Mathematics) 格仔版 (數學科)

Mobile Whiteboard 活動白板



MH series

Mobile Porcelain Enamel Magnetic Whiteboard (Single-sided) 活動搪瓷磁性白板 (單面)



MHTN Series



3mm round-safety corner
3毫米安全圓角



Strong and Safe Oval Shape stand base

- Made with 1.6mm thickness aluminum alloy
橢圓形活動底座腳，更安全穩固
- 使用1.6毫米厚身鋁合金底座，更加紮實穩固



Slightly slanted design

- More comfortable when writing on the bottom half of the board surface
- 1-Click safety lock to lock your writing surface firmly and is easy to use compare with butterfly screw
微傾斜設計
- 讓您於板面下半部份書寫時更舒適
- 活動架兩側設一Click安全鎖，有別傳統蝴蝶扣，使用更簡單、更安全



Plain 無印刷



MH48TN
W2526 x D610 x H1990



MH46TN
W1926 x D610 x H1990



MH36TN
W1902 x D610 x H1810

Grid line printed 暗線印刷



MH35TN
W1602 x D610 x H1810



MH34TN
W1302 x D610 x H1810

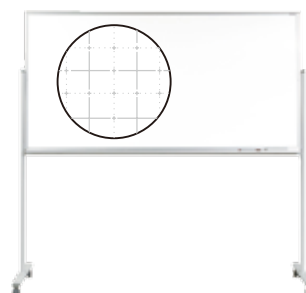

MH36TXN
W1902 x D610 x H1810

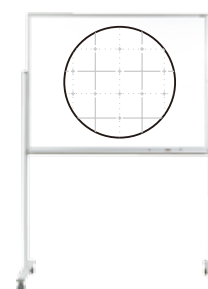

MH34TXN
W1302 x D610 x H1810

Mobile Porcelain Enamel Magnetic Whiteboard (Double-sided) 活動搪瓷磁性白板 (雙面)

MHTDN Series



3mm round-safety corner
3毫米安全圓角



Strong and Safe Oval Shape stand base
• Made with 1.6mm thickness aluminum alloy
橢圓形活動底座腳 · 更安全穩固
• 使用1.6毫米厚身鋁合金底座 · 更加紮實穩固



One-click safe lock

- Fix your writing surface firmly and is easy to use compare with butterfly screw.
- Push the one-touch stopper to flip the board vertically, minimize your room to switch between writing surface for double-sided whiteboard.

一Click安全鎖

- 有別於傳統的蝴蝶扣, 使用更簡單、更安全。
- 按下左右兩邊「PUSH掣」 · 垂直360度旋轉設計, 讓您用最少的空間便可交替板面, 靈活擺位, 書寫範圍即時增加一倍。

Plain 無印刷



MH48TDN
W2526 x D610 x H1990



MH46TDN
W1926 x D610 x H1990



MH36TDN
W1926 x D610 x H1840

Grid line printed 暗線印刷



MH35TDN
W1626 x D610 x H1840



MH34TDN
W1326 x D610 x H1840

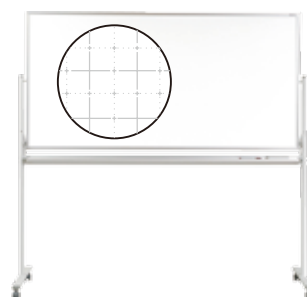

MH36TDXN
W1926 x D610 x H1840

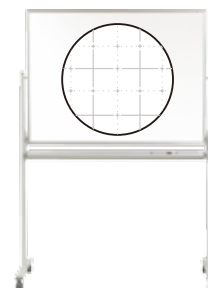

MH34TDXN
W1326 x D610 x H1840



Connectable Mobile Frameless Magnetic Whiteboard (Double-sided) 可連結活動無邊框磁性白板 (雙面)

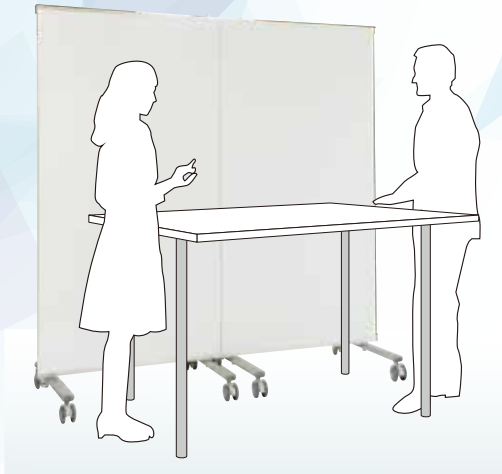

PVV-3M
Outer size: W892 x D610 x H1780
Whiteboard size: W880 x H1620



PVV-4M
Outer size: W1192 x D610 x H1780
Whiteboard size: W1180 x H1620

Safety Round Corner 安全圓角



Large Casters 大滾輪 Lockable 可鎖



Connectable 可連結

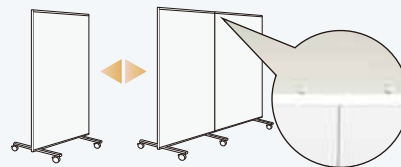

Can be used standalone or connect with more panels. The connecting part is frameless and flat.
可單獨使用，也可連結更多版面。連接部分無框且平坦。

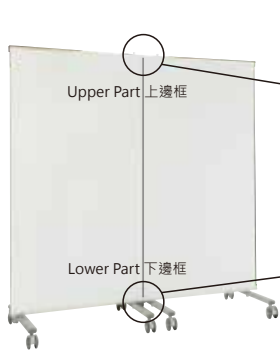

Connecting bracket set 連接金具套裝

[For upper mounting]
Connecting bracket (long)
[連接上邊框] 連接金具 (長)



[For lower mounting]
Connecting bracket (short)
[連接下邊框] 連接金具 (短)

VPVA-SET

Double-sided Magnetic Meeting Board in Black Frame (Whiteboard / Glossy Blackboard) 黑色邊框雙面磁性會議白板 (一面白板/一面光面黑板)

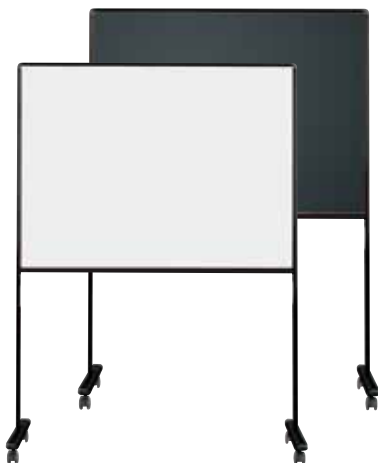

UDMT34K
Outer size: W1247 x D557 x H1750
Whiteboard size: W1183 x H880

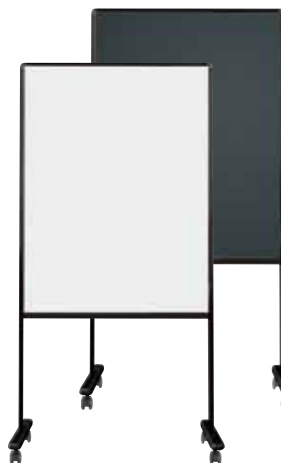

UDMT34KU
Outer size: W947 x D557 x H1850
Whiteboard size: W883 x H1180

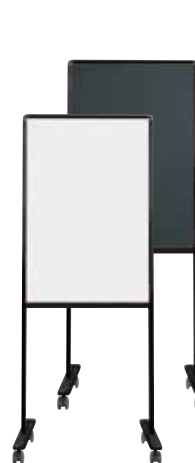

UDMT23KU
Outer size: W647 x D460 x H1620
Whiteboard size: W583 x H880



Glossy blackboard can be written with POP Gel Chalk
光面黑板可使用多用途粉筆書寫



Magnetic Pen Tray
磁性筆盤

Height Adjustable Whiteboard (Mobile) 上下升降白板 (活動式)

Height adjustable design to reduce your shoulder/waist pains due to intensive writing.
可調節高度，能有效減輕因長期書寫對肩及腰所造成的負擔。

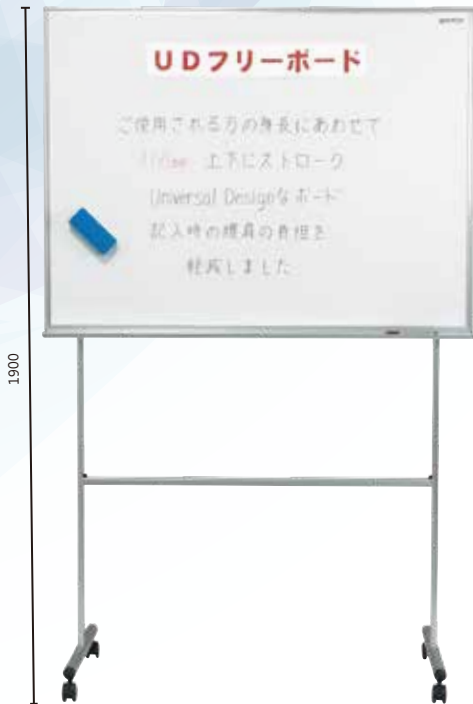

UDF36N
Outer size: W1810 x D657 x H1900~1500
Whiteboard size: W1810 x H910



Smooth sliding from 1500 to 1900mm, suitable for people with different height
能於 1500至1900毫米之間任意移動，順滑設計，適合不同高度的人仕使用

UDF34
Outer size: W1210 x D557 x H1900~1500
Whiteboard size: W1210 x H910

50mm grid square to assist your writing
白板表面印有50mm 暗格方便書寫

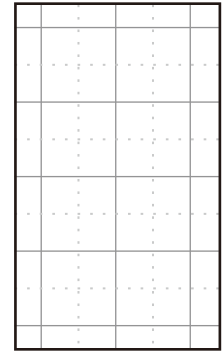

Stop and lock at any point between 1500mm – 1900mm, protect users get hurt from accidental sliding
讓你隨時隨地調節板面高度，適合不同高度的人仕使用
獨特安全設計，減低推板時受傷的機會

Adjustable height welcomes people with disabilities
板身可調節不同高度，方便傷健人仕使用



UD Meeting Board (Mobile) UD 會議白板 (活動式)

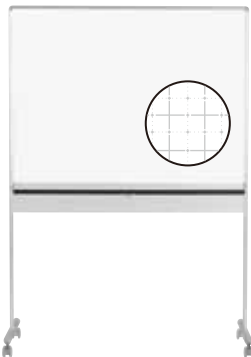

UDMT34
Outer size: W1247x D557 x H1750
Whiteboard size: W1183 x H880

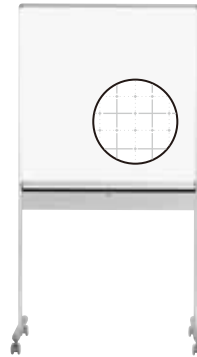

UDMT33
Outer size: W947x D557 x H1750
Whiteboard size: W883 x H880



Tube Frame and Round safety corner design
安全邊框和圓角設計



Shutter Pen Case
開合式筆盤

Open when use, neat and tidy.
需要時打開取筆，整齊清潔



Transparent Board (Mobile) 透明板 (活動式)



New and spacious board experience! Use it in your ways!
零壓迫感！有效擴潤視野，誘發前所未有的寫字板新用法！



Features

- Clear Acrylic Board with Special Treatment for smooth writing surface, reflect bright and vivid marker color
- Board thickness 5mm
- Oval Shape Aluminum Alloy Mobile Stand in 25mm thickness
- Safety Round Grey Color Cap

特點

- 特殊加工表面，令書寫更清晰
- 纖巧設計，厚度只有 5mm
- 鋁合金橢圓邊框：厚度 25mm
- 灰色注塑安全圓角



UDTP36YNZ
Outer size: W1847 x D557 x H1750
Whiteboard size: W1783 x H883
Weight: 19.7 kg



UDTP36NZ
Outer size: W947x D557 x H2030
Whiteboard size: W883 x H1783
Weight: 17.2 kg

Accessories 附加產品



Glassboard Eraser x 1pc
Glassboard markers (6-color) x 1 set
Multi-purpose Magnet Tape x 1pc
玻璃板刷 x 1個
玻璃板筆 (6色) x 1套
多用途磁石貼 x 1卷



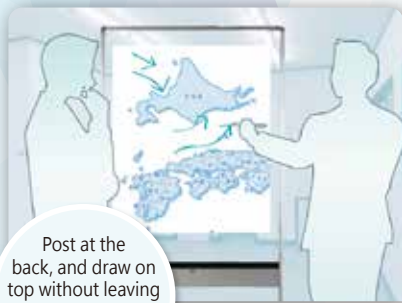

Post at the back, and draw on top without leaving marks on your poster or documents.



Look brighter and spacious with the light see-through.



Show your artwork in the way with words highlight.



Without blocking the view of the room. (e.g. library, exhibition, shop, warehouse)



Use as a notice board. Sense of style, and space is UP!



Use in any ways. More than you can imagine before you have it.



WMTP34N
Outer size: W895x D555 x H1835
Whiteboard size: W835 x H1185
Weight: 10kg

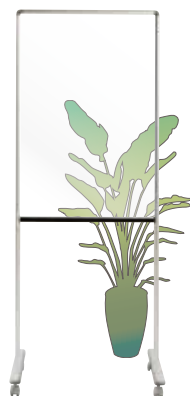

UDTP23NZ
Outer size: W648x D460 x H1620
Whiteboard size: W584 x H883
Weight: 10.9 kg



UDTP34NZ
Outer size: W947x D557 x H1850
Whiteboard size: W883 x H1173
Weight: 12.6 kg



UDTP34YNZ
Outer size: W1237 x D557 x H1750
Whiteboard size: W1173 x H883
Weight: 13.3kg

Accessories
附加產品



Glassboard Eraser x 1pc
Glassboard markers (6-color) x 1 set
Multi-purpose Magnet Tape x 1pc
玻璃板刷(1個)
玻璃板筆(6色)x1套
多用途磁石貼x1卷

Special coating
特殊塗層



Special coating for smooth writing (single-sided)
特別塗層讓書寫更暢順(單面)

Round Corner
圓角設計



Safety round corner design
安全圓角設計

Add-on Purchase 可供單購



R608-P
Transparent board eraser
透明板專用刷

R608-SP
Transparent board eraser refill (3pcs)
透明板專用刷替換(3個)



BGB-6 PS
Glassboard markers (6-color)
玻璃板筆(6色)

Projection Whiteboard 投影白板



Non-Reflective Porcelain Enamel Magnetic Whiteboard
不反光搪瓷磁性白板



Whiteboard for Projection and Writing use
將白板和投影屏幕二合為一

User can write and erase over the projected images

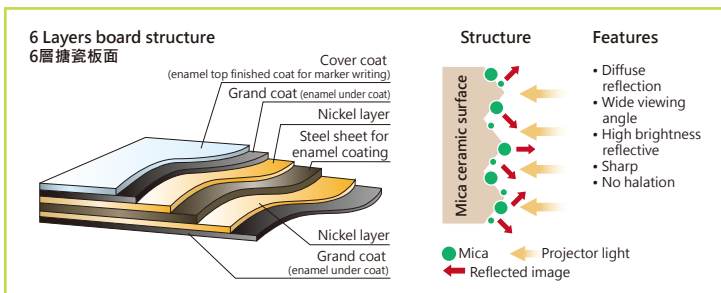
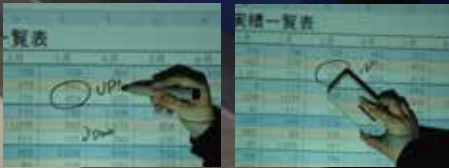

Features

- User can write and erase over the projected images
- Luster Level: under 23% (GS45°), eliminate the lens reflection effectively
- Porcelain Enamel containing special mica treated and embossed
- Mica ceramic technology applied to the screen diffuses reflection
- The board surface is made of inorganic, incombustible material similar in quality to glass, which produces neither smoke nor toxic gas when exposed to fire
- Writings and stains can be removed with wet cloth without damaging the surface or causing discoloration

特點

- 可直接投影於板面上，並以一般白板筆書寫
- 板面光澤度 (GS45) 低於23%，完全消除投影的刺眼光圈
- 色彩偏差縮小至1.5，令投影映像更鮮明
- 採用Mica ceramic 技術，能有效消除投影的反射光圈，讓使用者在任何角度都能清楚看到映像
- 摩氏硬度 5.5 日本搪瓷製成，堅硬耐用
- 搪瓷白板高效防銹及防脫色

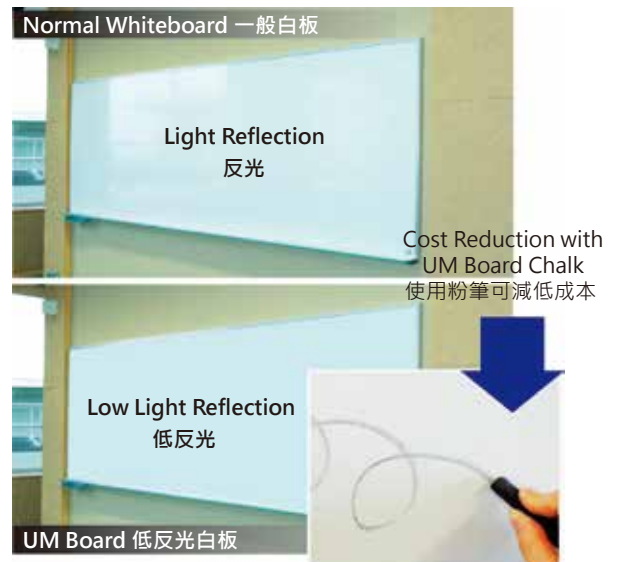

Non-Reflective Porcelain Enamel Magnetic Whiteboard 不反光搪瓷磁性白板



Wall-mount Series 掛牆系列

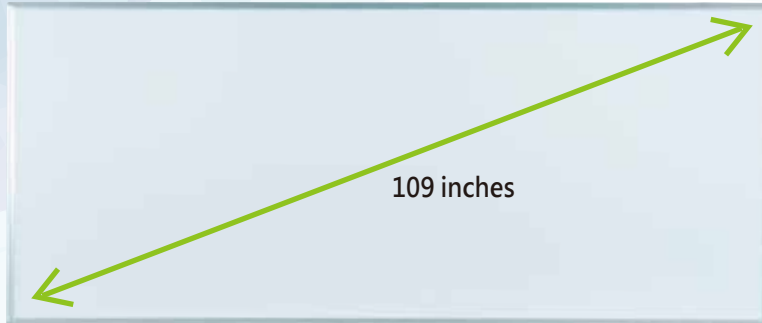

UM58N
Outer Dimensions / W2410×H1520
Board Dimensions / W2370×H1480
Pen Tray / L =2400

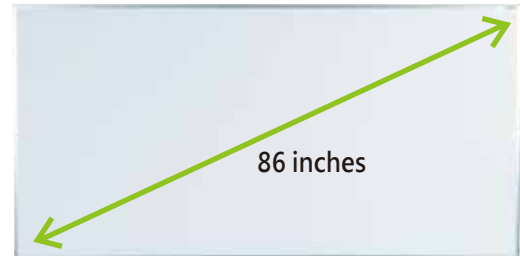

UM48N
Outer Dimensions / W2410×H1210
Board Dimensions / W2370×H1170
Pen Tray / L =2400

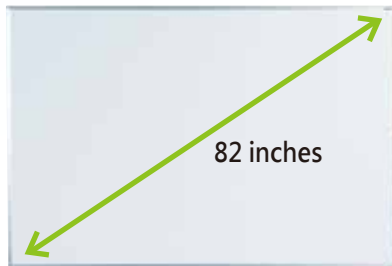

UM46N
Outer Dimensions / W1810×H1210
Board Dimensions / W1770×H1170
Pen Tray / L =1800

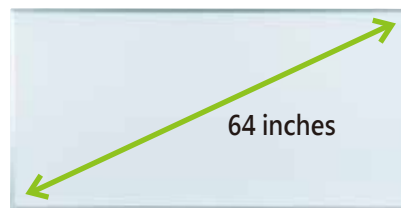

UM36N
Outer Dimensions / W1810×H910
Board Dimensions / W1770×H870
Pen Tray / L =1800

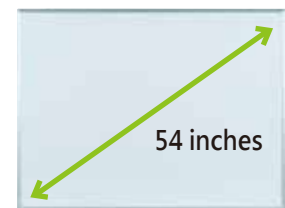

UM34N
Outer Dimensions / W1210×H910
Board Dimensions / W1170×H870
Pen Tray / L =1200

Mobile Series (Single-sided / Double-sided) 活動式系列 (單面 / 雙面)

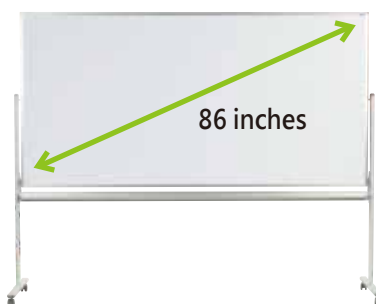

UM48T / UM48TD
External Dimensions / W2526×D610×H1990
Outer Dimensions / W2410×H1210
Board Dimensions / W2370×H1170

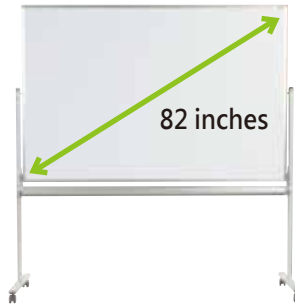

UM46T / UM46TD
External Dimensions / W1926×D610×H1990
Outer Dimensions / W1810×H1210
Board Dimensions / W1770×H1170

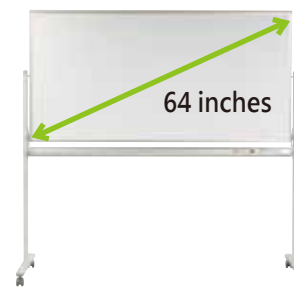

UM36T / UM36TD
External Dimensions / W1926×D610×H1840
Outer Dimensions / W1810×H910
Board Dimensions / W1770×H870

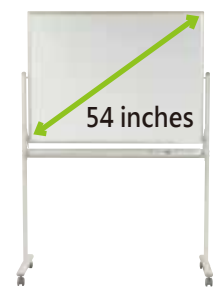

UM34T / UM34TD
External Dimensions / W1326×D610×H1840
Outer Dimensions / W1210×H910
Board Dimensions / W1170×H870

* Projection image size is measured in 16:10 for reference
投影尺寸按 16:10計算, 只供參考

Seamless Non-Reflective Projection Whiteboard 無縫不反光投影白板



On-site installation 10000(W) x 1500(H)mm

Features

- No conjunction line on the board surface
- Flexible for projected image position, hustle free for projector screen boundaries
- Ultra Slim board thickness in 5mm only *
- Frame thickness in 20mm
- Concealed installation, no screws will be shown
- Compatible with all projectors

* depends on the on-site environment. Board thickness also available for 34.5mm

特點

- 無縫板面, 板面沒有接駁位
- 不用受投影屏幕尺寸限制, 令投影位置更靈活彈性
- 緊貼牆身纖巧設計: 板面厚度只有 5毫米 *
- 鋁合金邊框厚度20毫米
- 隱閉式安裝, 不會外露螺絲
- 所有投影機均適用

* 需視乎現場環境是否適用, 同時備有34.5毫米板材可供選擇

Write and erase over projected images.
可於投影影像書寫及擦拭



Frame Color 邊框顏色



Standard 標準色



White 白色

Projector Board Accessories 投影白板相關產品



R508P
Complete Sponge
Whiteboard Eraser
全效型海綿白板刷
Size: 150L x 58W x 42H mm



R508S-2P
Complete Sponge
Whiteboard Eraser (Refill)
全效型海綿白板刷 (替芯)
Size: 150L x 50W x 40H mm

R508C
Magnetic Eraser Cleaning Board
磁性白板刷清潔板
Size: 156(W) x 236(H) x 10(thickness)mm



Simply stick it on any magnetic surface
可貼於任何磁性表面上



Rub on the
cleaning board
softly, eraser will
become white
again!
掃一掃, 白板刷
立即光潔如新!

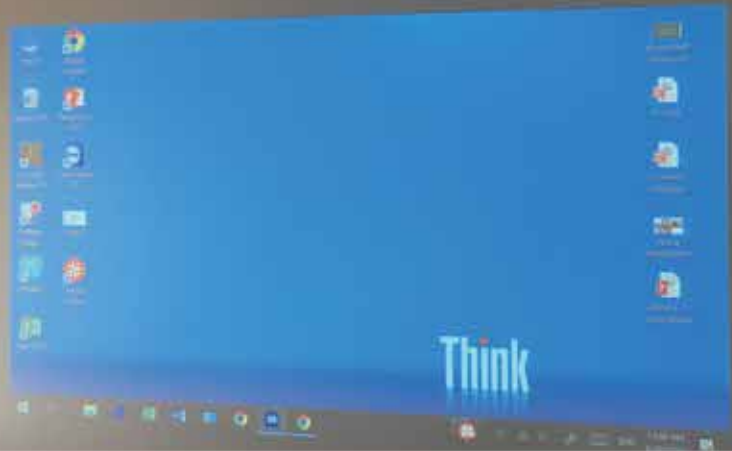

UM Ultra Slim Series 3300(W) x 1500(H)mm
(in 5mm thickness only)

Interactive Whiteboard New Solution 互動白板新方案

Interactive Whiteboard & Traditional Writing at the same time!

UMA-JIRUSHI low reflective projection whiteboard provides 1.2m and 1.5m height for option, it is compatible with all brands of short flow interactive projector available in the market. The maximum size of projection surface is 109 inches, together with the interactive function built in the projector, it immediately turns the projected area into a huge touch screen monitor which shares the same features of electronic whiteboard. In addition, you can write on the board surface with traditional whiteboard markers.

互動白板 & 白板筆書寫 能同時進行!

馬印低反光投影板提供 1.5米和1.2米的高度選擇，配合市面上任何品牌的互動式短投機，能投射出至109吋的影像，同時亦將投射影像變身為輕觸式屏幕，您可用手點擊和操控投射的範圍，功能與一般電子白板無異。白板表面可使用普通白板筆書寫，讓你真正做到邊投影邊書寫。

Features of UMA-JIRUSHI Interactive Whiteboard Solution 馬印互動白板特色

Display Area 投影範圍	Up to 109 inches and can be adjusted at anytime. 最大投影範圍是 109寸, 可按環境放大縮小投射影像
Change Display Size 更改投影尺寸	Anytime, up to 109 inches * for 1500mm height whiteboard 隨時, 最大投影範圍是 109寸 *以1500高度的白板計算
Ustainability 耐用性	High 高
When electricity is off 斷電時	Can be used as whiteboard 仍可作白板使用
Thickness 厚度	Board thickness available at 5mm / 18mm / 34.5mm 板身厚度有5毫米, 18毫米及34.5毫米選擇
Overall Appearance 外觀	Perfect minimal design 簡潔不佔空間
Writing 書寫	Whiteboard marker / UM board chalk 白板筆 / 馬印投影板專用粉筆

Whiteboard Sheet 白板貼

Fully utilized your room and space
善用室內的空間



You can write, you can stick!
Magnetic surface, you can stick any kind of papers, memos, notes or poster on it. Of course, you can also write on the surface with whiteboard markers.

可書寫，也可張貼!
磁力表面，可讓您張貼紙張，備忘錄，便條或海報!當然，你也可以在表面書寫，任何白板筆均適用。



Roll packing, easy to install!
Packed in roll, easy for storage, you can cut the size or shape to suit your needs, the junction line is perfectly hidden and not easy to spot out.

卷裝白板貼，容易安裝!
卷裝包裝，易於收藏，您可按自己需要裁切不同尺寸或形狀，併合時接駁位並不明顯。



Easy to install in all kind of surface
Self-adhesive backing allows you to apply on any smooth and flat surface.

容易安裝於不同表面
背部是自動黏貼，可張貼於任何平滑的表面。



Adhesive-back Magnetic Whiteboard Sheet (Glossy) 黏貼式磁性白板貼 (光面)



Adhesive-back, easy to stick on
黏貼式底部, 一撕即貼



Suitable to post on glass, door, old whiteboard/blackboard or any smooth and flat surface
適用的位置: 玻璃、門、舊白板/黑板或平滑的表面。

Thickness 厚度	Width 寬度	Longest Length 長度
1.0mm	1020mm	10 meters

Can cut into any sizes or shapes
可裁切為不同形狀

無痕
No adhesive dirt remains on the wall surface after removal (e.g. glass)
撕去白板貼後不會遺留膠水漬

1.0 mm
Thickness in 1.0mm, to ensure product durability
厚度1.0mm更堅韌耐用

Adhesive back, easy to stick on
黏貼式底部張貼更方便

Magnetic-back Low-Reflective Whiteboard Sheet (Matt) 磁力底低反光白板貼 (啞面)



It is a whiteboard, and it is a projector screen
可作白板及投影屏幕使用

Allow you to write on projected image
可於投影映像上書寫

Can cut into any sizes or shapes
可裁切為不同形狀

Magnetic-back, easy to put on top of magnetic surface (e.g. existing whiteboard / greenboard)
磁力底方便張貼於磁性表面上 (例如: 原有白板或綠板)

Thickness 厚度	Width 寬度	Longest Length 長度
0.4mm	1220mm	20 meters

Notice Board 告示板



K series

One-way Artificial Leather Notice Board 人造皮革告示板



Features

- Elastic surface, minimize trace of pin-marks
- Cleanable surface
- Round-shaped safety corner design
- Board thickness from 18mm to 34.5mm (depends on the board width)
- You can tailor made the size of the board

特點

- 富彈性的人造皮革表面, 減低釘孔遺留的痕跡
- 表面可清洗, 方便打理
- 安全注塑角位
- 板身厚度 18毫米至34.5毫米 (視乎板的長度而定)
- 你可自訂尺寸

Model No. 型號	Size 尺寸 (mm)
K23	W910×H610
K34	W1210×H910
K36	W1510×H910
K46	W1810×H1210
K48	W2410×H1210



Color 顏色



#708 Green 綠

#711 Grey 灰

#712 Ivory 象牙

#733 Light Green 淡綠

#741 Blue 藍

Two-way Magnetic Artificial Leather Pin Board 磁性及圖釘兩用人造皮革告示板

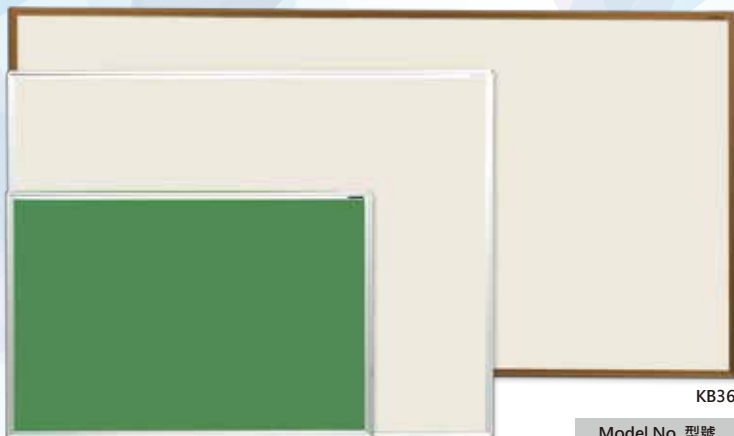

KB23 KB34

KB36

Model No. 型號	Size 尺寸 (mm)
KB23	W910×H610
KB34	W1210×H910
KB36	W1810×H910
KB46	W1810×H1210
KB48	W2410×H1210

Features:

- Magnetic surface can be used with pins, staples and magnets.
- Artificial leather surface can be wiped with a damp cloth.
- 磁性版面可同時使用圖釘、釘書釘及磁石。
- 人造皮革面, 可用濕毛巾抹擦, 方便清潔。



Two-way Magnetic Cork Pattern Pin Board 磁性及圖釘兩用水松紋告示板

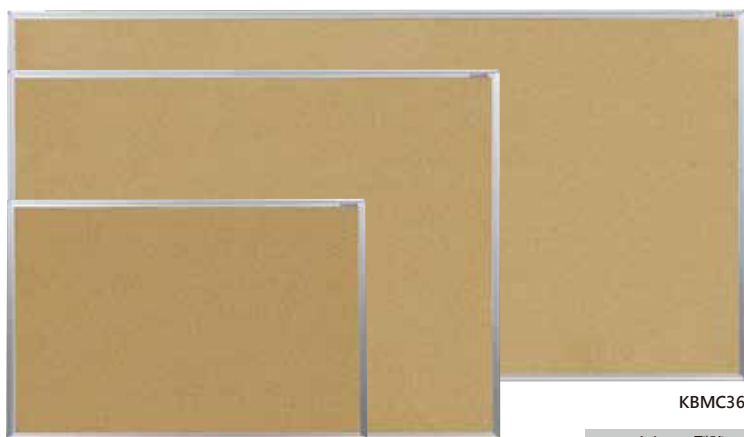

KBMC23N KBMC34N

KBMC36N

Model No. 型號	Size 尺寸 (mm)
KBMC23N	W910×H610
KBMC34N	W1210×H910
KBMC36N	W1810×H910
KBMC46N	W1810×H1210
KBMC48N	W2410×H1210

Color 顏色



#910 Green 綠



#912 Ivory 象牙白



#914 Cork Pattern 水松紋

Frame Color 邊框顏色



Silver (Standard)
銀色 (標準色)

Copper
銅色

Black
黑色

Silver (Standard)
銀色 (標準色)

Copper
銅色

Notice board with Fascia 帶招牌的展示板

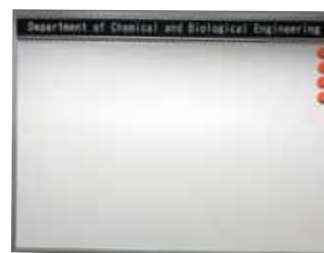

Fascia can be tailor-made on top of notice board. We have various colors for Fascia and font color selection. Welcome for inquiry.

可於展示板上加設招牌板, 招牌板及文字顏色均有多色選擇, 歡迎查詢。

Display Panel 連結展示板



Flexible to suit your needs 靈活彈性

Easy to assemble into combinations. No tools are required, boards can be connected and installed horizontally or vertically. Save space for storage.
可按不同活動，併出合適的展示組合。簡易組裝，無須工具。可置橫置直，且連結申延。可拆裝收藏，減少儲存空間。

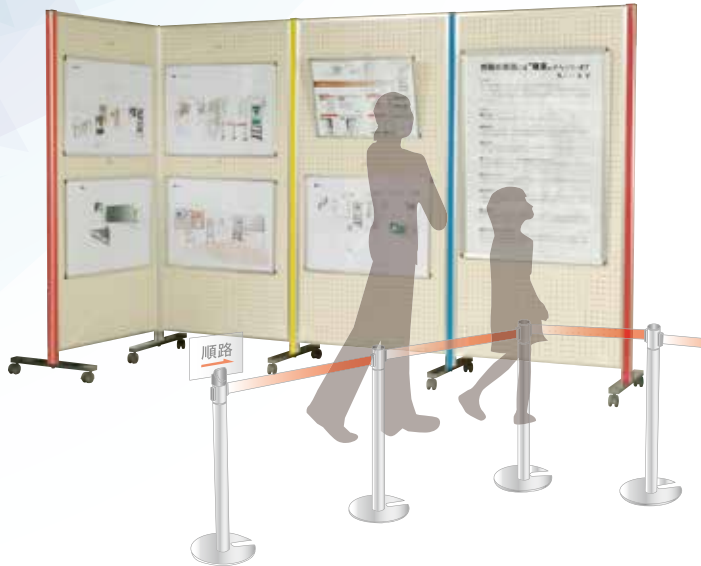

One-way Artificial leather notice board 人造皮革告示板



Color 顏色	
	708 Green 綠
	711 Grey 灰
	741 Blue 藍
	712 Ivory 象牙
	733 Evergreen 嫩綠

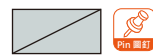

Double-sided 雙面

Model No.	Board Outer (mm)	Board Inner (mm)
ARK306	1800×900	1760×860
ARK307	2100×900	2060×860
ARK308	2400×900	2360×860
ARK406	1800×1200	1760×1160
ARK407	2100×1200	2060×1160
ARK408	2400×1200	2360×1160

Buckling position 扣位

Buckles are installed in the positions indicated.
扣位已內置於右圖指示的位置。

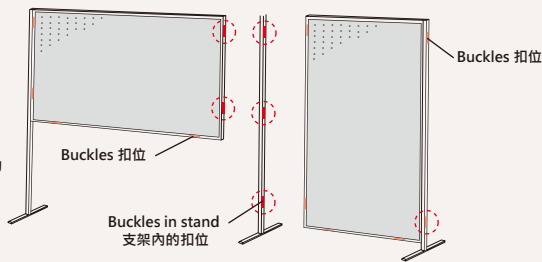

Save time in Assemble and Storage 節省組裝及拆裝的時間

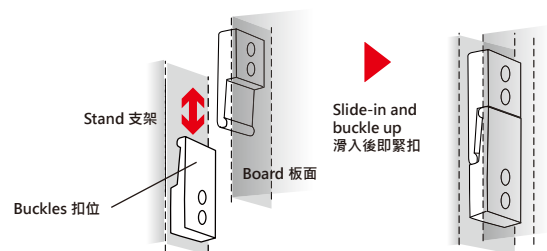

Aluminum Alloy Stand 鋁合金支架

		Flat Base 平腳	Anti-slip 帶防滑墊	With Rollers 帶滾輪	
<p>Cross Section 橫切面圖</p> <p>48</p> <p>Buckle 扣位</p> <p>4-sides with buckles 4面均附有扣位，方便安裝</p>	<p>Size and Model 尺寸及型號</p>	<p>500</p> <p>※ H=2100mm H=2400mm 590</p>	<p>550</p>	<p>550</p>	
		<p>1800mm</p> <p>AR306 AR406 ARK306 ARK406</p>	<p>AR48T18A4</p> <p>Overall Height = 1867mm</p>	<p>AR48T18B4</p> <p>Overall Height = 1895mm</p>	<p>AR48T18C4</p> <p>Overall Height = 1947mm</p>
		<p>2100mm</p> <p>AR307 AR407 ARK307 ARK407</p>	<p>AR48T21A4</p> <p>Overall Height = 2205mm</p>	<p>Color Frame for easy identification of display groups / functions 外置顏色邊框，清晰地為各展示區 / 活動分類</p> <p>Red 紅 Blue 藍 Yellow 黃</p> <p>Size 1800mm Model ARPC18</p>	
<p>2400mm</p> <p>AR308 AR408 ARK308 ARK408</p>	<p>AR48T24A4</p> <p>Overall Height = 2505mm</p>	<p>Cross Section 橫切面圖</p> <p>Buckle 扣位</p> <p>Color Frame 顏色邊框</p>			

Multi-purpose Partition Board 多用途間隔牆板



Board Surface 板面



Double-sided Magnetic Whiteboard
雙面磁性白板

Model No.	Board Outer(mm)	Board Inner(mm)
APVV304	W900×H1200	W860×H1160
APVV404	W1200×H1200	W1160×H1160
APVV305	W900×H1500	W860×H1460
APVV405	W1200×H1500	W1160×H1460
APVV306	W900×H1800	W860×H1760
APVV406	W1200×H1800	W1160×H1760

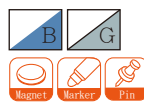

Magnetic Whiteboard / One-way Artificial Leather Notice Board
磁性白板 / 人造皮革告示板

Model No.	Board Outer(mm)	Board Inner(mm)
APVK-304	W900×H1200	W860×H1160
APVK-404	W1200×H1200	W1160×H1160
APVK-305	W900×H1500	W860×H1460
APVK-405	W1200×H1500	W1160×H1460
APVK-306	W900×H1800	W860×H1760
APVK-406	W1200×H1800	W1160×H1760

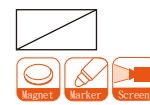

Magnetic Whiteboard / Non-reflection whiteboard for projection
磁性白板 / 不反光投影白板

Model No.	Board Outer(mm)	Board Inner(mm)
-	-	-
-	-	-
APMCV305	W900×H1500	W860×H1460
APMCV405	W1200×H1500	W1160×H1460
APMCV306	W900×H1800	W860×H1760
APMCV406	W1200×H1800	W1160×H1760

Double-sided One-way Artificial Leather Notice Board Combo in Three 雙面人造皮革告示板組合

Connected in 3 boards, can be flip in 360 degrees. Easy to setup and use. 三塊板連結在一起, 並可 360度調教。易於使用及收藏。



712 Ivory 象牙

711 Grey 灰

Model No.	Overall Size	Folded Size
VKK606F-I	W1800×D610×H1800	W611×D610×H1800
VKK609F-I	W2700×D610×H1800	W911×D610×H1800
VKK606FLB	W1800×D610×H1800	W611×D610×H1800
VKK609FLB	W2700×D610×H1800	W911×D610×H1800



Magnetic Pen Tray 磁性筆盤

Optional 可加配
Strong Magnet for better hold, do not fall while using.
Remove from board is easy without tool.
600mm and 900mm are available.
磁力特強, 不會掉落。移除亦方便。
備有 600毫米及 900毫米兩款尺寸。



Standard Heights 標準高度



Resin Wood Color Frame Series 木紋色樹脂邊框系列

Porcelain Enamel Magnetic Board 木紋邊框磁性及圖釘兩用人造皮革告示板

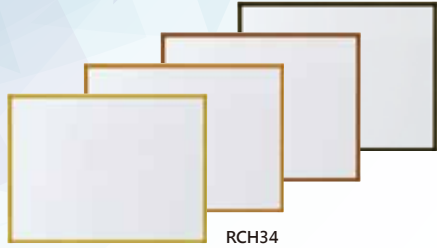

RCH34
Outer size: W1200 x D20 x H900
Board size: W1150 x H850

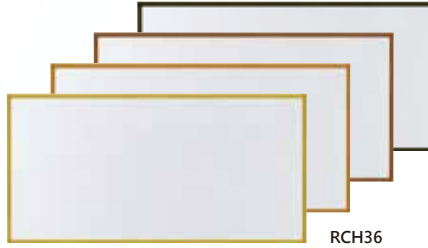

RCH36
Outer size: W1800 x D20 x H900
Board size: W1750 x H850

Two-way Magnetic Artificial Leather Pin Board 磁性及圖釘兩用人造皮革告示板

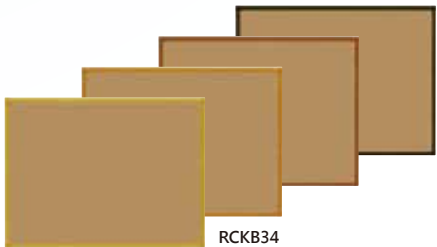

RCKB34
Outer size: W1200 x D20 x H900
Board size: W1150 x H850

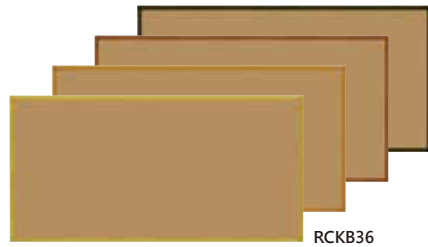

RCKB36
Outer size: W1800 x D20 x H900
Board size: W1750 x H850

Frame Color in wood pattern 木紋顏色邊框



WW: Black Wood
黑木紋色



WT: Dark Wood
深木紋色



WM: Wood
木紋色



WC: Light Wood
淺木紋色

ABS Frame Magnetic Glossy Blackboard 樹脂邊框磁性光面黑板



RCK36K Wooden Color Frame
W1800 x H900

RCV34K Blue Frame
W1200 x H900

Frame Color 邊框顏色



Wood Pattern 仿木紋
Brown 啡



Pink 粉紅
Blue 藍
Ivory 象牙白

Installation Guide 安裝方法

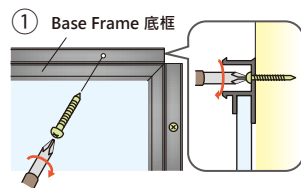

① Base Frame 底框
Fix the base frame with screws on the wall first.
先將底框以螺絲安裝至牆上

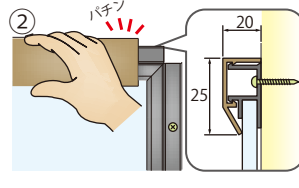

② Put the ABS frame on top of base frame, and push down until hear a "Ba" sound
將樹脂邊框放於底框上按下直至聽到“啲”一聲

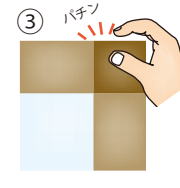

③ Put the ABS corner, and push down until hear a "Ba" sound
將樹脂角位放於底框上按下直至聽到“啲”一聲

Accessories 配件



POP GEL CHALK
(White) x 1pc

Glossy Blackboard 光面黑板



Magnetic Glossy Blackboard in Aluminum Alloy Frame 鋁合金邊框磁性光面黑板

Features

- Elegant and innovative design with glossy surface
- Perfect match with UMAJIRUSHI Pop Gel Chalk
- Magnetic surface
- Easy to clean by wet cloth
- Streamline aluminum frame in silver

特點

- 鋼琴黑光面設計，高貴優雅
- 配合馬印Pop Gel Chalk使用，效果加倍明顯
- 磁性板面
- 只需以濕布抹刷，清潔容易
- 流線型鋁合金銀色邊框

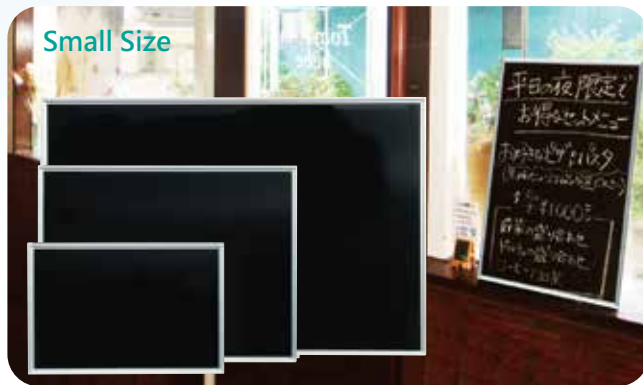

Small Size



Large Size

Corner 角位



Model No. 型號	Size 尺寸
MEB1	W460 x H310
MEB2	W610 x H460
MEB23	W910 x H610

Corner 角位



Model No. 型號	Size 尺寸
MEB34	W1210 x H910
MEB36	W1810 x H910

Magnetic A-Frame Chalkboard Sidewalk Sign 鐵製磁性A型廣告板



WA450VK

WA450VR

WA450VB

WA450VG

WA450VD

WA450VP

Display Case 展示箱



Porcelain Enamel Magnetic Whiteboard Display Case 搪瓷白板展示箱

Cover: Transparent Acrylic, 3mm thickness 面板: 3mm 厚度透明亞克力

Mobile type 流動式

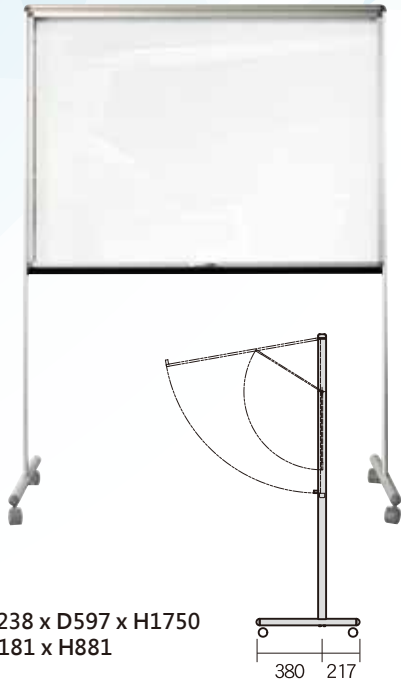

UDKU34T
Outer size: W1238 x D597 x H1750
Board size: W1181 x H881
Weight: 19.2kg

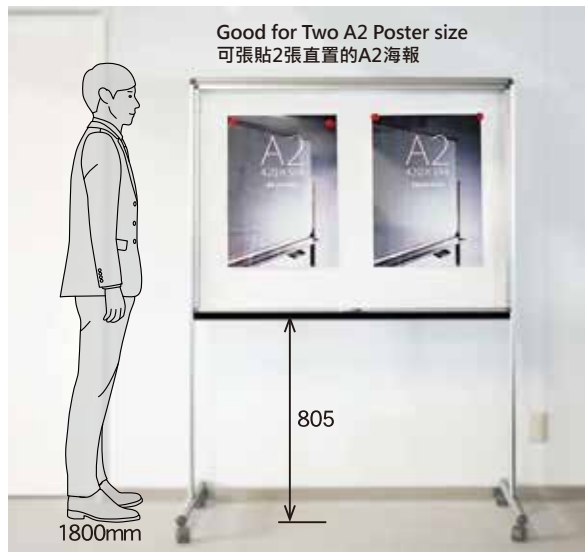

Wall-mount Type 掛牆式

Horizontal use 橫置使用

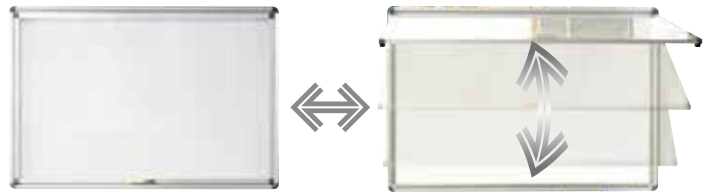

Vertical use 直置使用

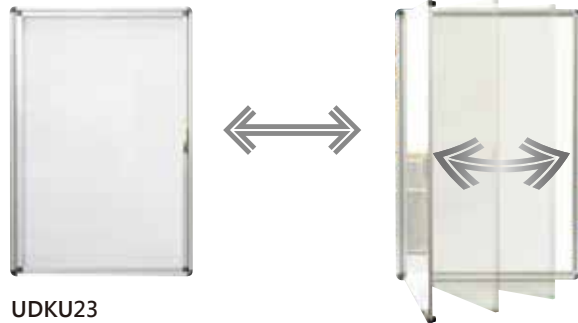

UDKU23
Outer size: W938 x D46 x H638
Board size: W881 x H581
Weight: 9.4kg



Push Lock with Key
可按下鎖頭 (附鎖匙)



Enamel whiteboard surface, writable and durable
搪瓷白板面, 可書寫, 且耐用

Poster Frame 海報架

Light Weight Poster Panel 輕巧式海報展示架



QE Series / QE-C Series

Model No. 型號	Size 尺寸	Frame Size 外形尺寸
QE-A1	A1 (594× 840)	609× 855
QE-A2	A2 (420× 594)	435× 609
QE-A3	A3 (297× 420)	312× 435
QE-A4	A4 (211× 297)	226× 312
QE-B1	B1 (728×1030)	743×1045
QE-B2	B2 (515× 728)	530× 743
QE-B3	B3 (364× 515)	379× 530
QE-B4	B4 (257× 364)	272× 379
QE-P1	全紙 (440× 550)	455× 565
QE-P2	半切 (345× 423)	369× 438
QE-P4	四ツ切 (243× 294)	258× 309



Poster Frame 海報展示架



Model No. 型號	Size 尺寸	Frame Size 外形尺寸
QM-A1	A1 (594× 840)	641× 887
QM-A2	A2 (420× 594)	467× 641
QM-A3	A3 (297× 420)	344× 467
QM-B1	B1 (728×1030)	775× 1077
QM-B2	B2 (515× 728)	562× 775
QM-B3	B3 (364× 515)	411× 562
QM-B4	B4 (257× 364)	304× 418



Poster Frame Stand (Panel is not included) 座地式海報展示架 (不包括海報架)

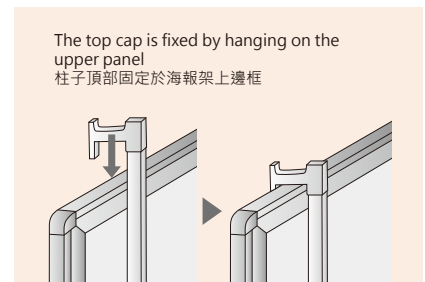

Suitable for 30mm thickness Poster Frame
適用於30mm厚度海報架

Suggested Poster Frame width
建議海報架寬度
JVS70/ 400~750mm(W)
JVS80/ 550~900mm(W)
JVS90/ 700~1200mm(W)

School Series 學校系列

MS series

Magnetic Greenboard (Wall-mount) 磁性綠板 (掛牆式)



Flexible for Horizontal and Vertical Installation.
產品可置橫或置直安裝。

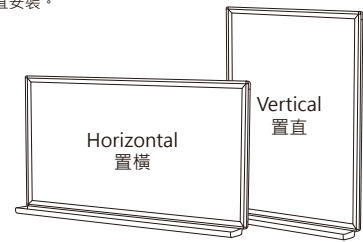

Movable Hangers 活動掛鉤

Size 23 or above



Size 2 or below



Model No. 型號	Size 尺寸	Pen Tray 筆盤
MS23	W910 × H610	900
MS34	W1210 × H910	1200
MS35	W1510 × H910	1500
MS36	W1810 × H910	1800
MS46	W1810 × H1210	1800
MS48	W2410 × H1210	2400

MS Series

Features

- Board thickness in 18mm
- Assembled by machine to ensure the smoothness of the board surface, you can write and erase writings easily
- Aluminum Alloy Frame thickness is 18mm

特點

- 綠板厚度只有18mm
- 板面以機械壓制而成，保證板面受力均勻、平滑，不易變形，而且易寫易擦
- 流線型鋁合金邊框

Magnetic Greenboard (Mobile) 磁性綠板 (活動式)



Width of board from 910 to 2410 mm
板身長度由910至2410毫米

Slightly slanted design 微傾斜設計

more comfortable when writing on the bottom half of the board surface.

讓您於板面下半部書寫時更舒適。

* excluding size 46 / 48



Single-sided 單面

One-click safe lock 安全鎖

Fix the writing surface firmly while using. Push to release and rotate the board easily. 書寫時穩固板面。按下左右兩邊掣位，即可垂直回轉板面。

Suitable from size 34 to 48
適用於34至48尺寸



Double-sided 雙面

Large Whiteboard/Greenboard/Noticeboard (Mobile) 大型白板/綠板/告示板 (活動式)



Width of board from 1800 to 2700mm
Standard height of board 915mm or 1215mm



30mm thickness with round corner protection design

30mm厚度及圓角防護設計

Thick aluminum alloy base design to ensure the product stability

特厚鋁合金底座, 加強產品的穩固性

Enhance board mobility and stabilized the board surface when writing

改善移動時的效果和書寫時板面的穩定性

板身長度由1800至2700毫米
標準板身高度為915毫米或1215毫米

Double-sided Foldable Mobile Enamel Magnetic Whiteboard / Notice Board 雙面可摺合式活動搪瓷磁性白板/展示板

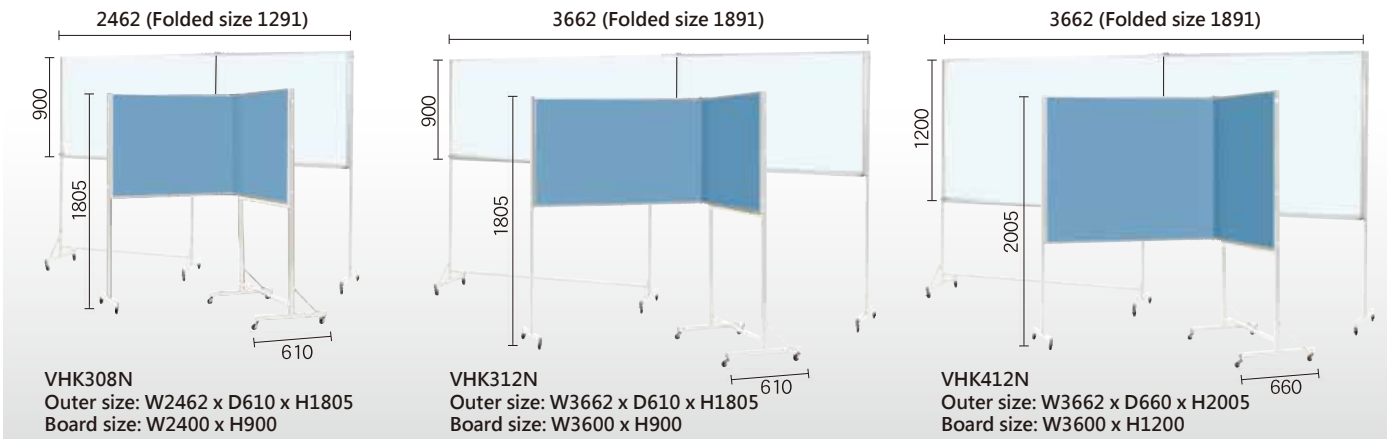

5-Faced Magnetic Greenboard / 5-Faced Magnetic Enamel Whiteboard 五面磁性綠板 / 五面搪瓷磁性白板

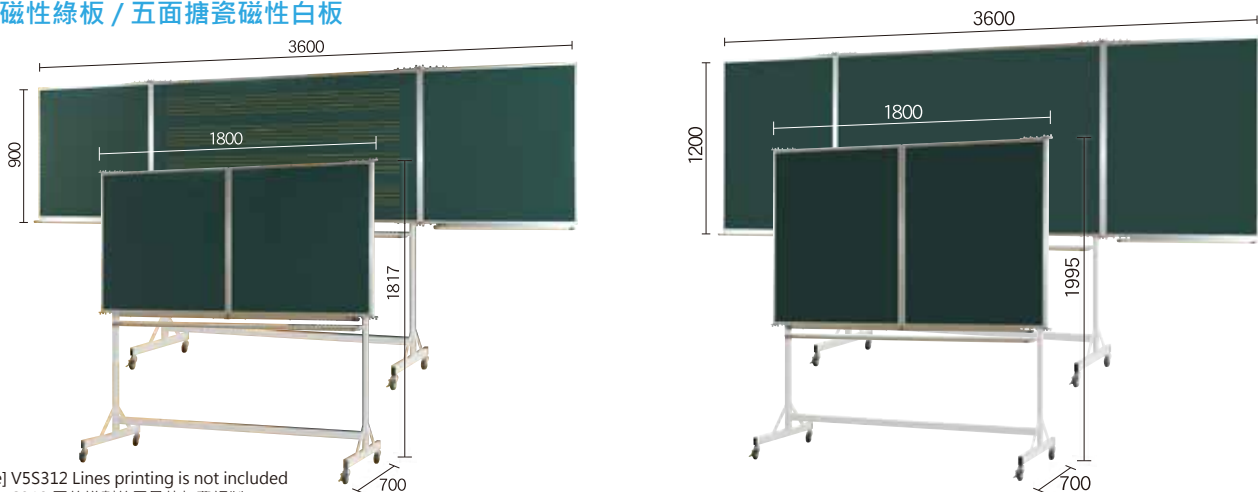

[Picture] V5S312 Lines printing is not included
[圖片] V5S312 五線譜劃線需另外加費訂製

V5S312N (Greenboard 綠板)
Board size: W3600 x H900



V5H312N (Whiteboard 白板)
Board size: W3600 x H900



V5S412N (Greenboard 綠板)
Board size: W3600 x H1200



V5H412N (Whiteboard 白板)
Board size: W3600 x H1200



Mega Whiteboard/Greenboard/Noticeboard 超大型白板/綠板/告示板

Suitable from board width in 5400mm or below, standard height available in 900 / 1200 / 1500mm
適用於5400毫米以下板面寬度,標準板面高度為 900/1200/1500毫米



HA412岐阜縣多治見市滝名小學校實景拍攝



Magnetic Greenboard
磁性綠板



Porcelain Enamel Magnetic Greenboard
搪瓷磁性綠板

Features

- Board thickness in 34mm
- Magnetic surface (excluding notice board)
- Full length Pen tray is attached (excluding notice board)

特點

- 板身厚度34mm
- 磁性板面(告示板除外)
- 附有同等長度的筆盤(告示板除外)



Porcelain Enamel Magnetic Whiteboard
搪瓷磁性白板



Non-Reflective Porcelain Enamel Magnetic Whiteboard
不反光搪瓷磁性投影白板



Low Reflective Porcelain Enamel Magnetic Whiteboard
低反光搪瓷磁性白板



One-way Artificial Leather Notice Board
人造皮革告示板

Optional Accessories 可額外選購的配件



Pen Box 白板筆收納盒



Chalk Box 粉筆收納盒



Movable Document Hanger 活動掛紙夾

Wall-mount Vertical Sliding Whiteboard 掛牆式大型上下升降白板



Features

- Fully utilize the height of the wall, even the audience sitting at the back can also see the writings clearly
- Smooth sliding
- Round corner safety design
- Enclosed Aluminum Alloy Frame durable for frequent use

特點

- 讓您善用整個牆身的高度, 即使坐在後排的觀眾也能清楚看到板面
- 移動順暢
- 圓塑角位安全設計
- 封密式鋁合金框架, 堅固耐用

HAU610
W3000 x H1800
※香港海關大樓實景拍攝

Standalone Vertical Sliding Whiteboard 柱立式上下升降白板



Features

- No need to install on wall surface.
- Can choose for Single-sided or Double-sided
- Recommended board size within 1800mm
- Suitable for room height from 2.3 to 3.1 meters

特點

- 無須安裝於牆壁上, 提供更佳的靈活性。
- 可選擇製作單面或雙面
- 建議的板面長度為1800mm以內
- 適合地下至天花介乎2.3至3.1米

BHCU66
W1800 x H910 (2pcs)

Horizontal Sliding Board 多屏活動板



Integrate your best combination to suit your needs in limited classroom space
善用課室空間, 展現多元板面組合

*Photo taken at W F Joseph Lee Primary School
和富慈善基金李宗德小學 實境拍攝

Can choose from the below board surface 可選擇以下板材

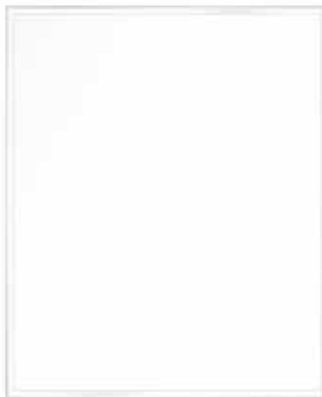

Magnetic Whiteboard
磁性白板



Magnetic Greenboard
磁性綠板

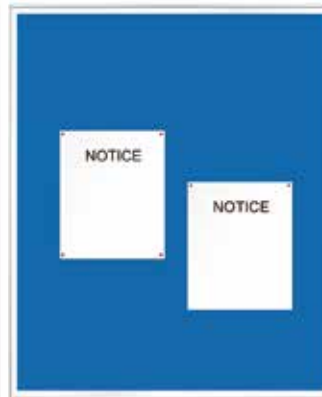

Artificial Leather Notice Board
人造皮革壁報板



Laser-Print Whiteboard
激光劃線板

Safe

Enclosed frame design to avoid detachment of boards under frequent usage

Smooth

All wheels and aluminum rail are made in Japan to ensure smooth sliding of the boards

Flexible

Tailor-made size with free combination of board surface

安全

封密式框架, 防止寫字板因頻密移動而脫落

順滑

日本製造的滾輪和鋁合金路軌, 確保板面暢順移動

靈活

可按環境要求, 自訂尺寸和選擇不同的板面組合

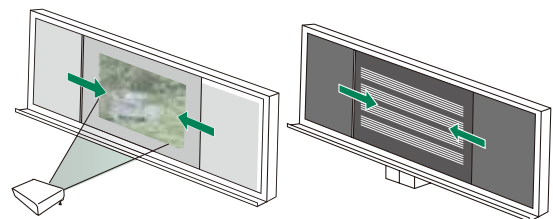

Low reflection whiteboard fixed in base layer. Top layer slide boards can be move left or right

使用投影白板作為底板, 上層的板材可左右移動

Board Renewal 板面翻新

Get a new board surface without complicated mounting and remove works!
無須拆除舊板即可擁有全新板面!



UMAJIRUSHI whiteboard sheet solution is easy to set up, clean and tailor-made fit for your size at ease. No need to remove and dispose existing board for a brand new projection and writing surface. With magnetic backing you can attach to metal surfaces or other magnetic materials easily. The whiteboard sheet features a smooth, white vinyl surface that is suitable for dry erase markers and magnetic accents to easily jot down notes and make presentations.

馬印磁性白板貼免除複雜的安裝步驟，無須拆卸舊有的白板使可更換全新的書寫板面，白板貼背後有磁力，可覆蓋在任何鐵製或有磁力的表面，白板貼提供暢順的書寫面，易刷易寫，容易打理。

No Removal
無須移除

No Disposal
無須棄置

No wall
renovation works
無須牆身裝修工程

Can replace
with whiteboard surface
可改用白板板面

Magnetic surface
磁性表面

Environmental-Friendly
環保

Smooth for writing
書寫順滑

Low Reflection
低反光

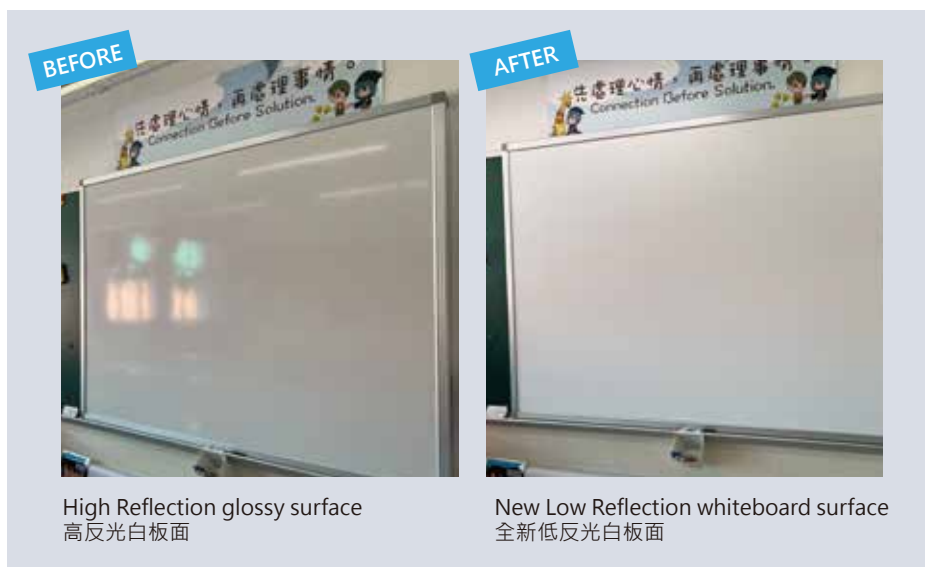

High Reflection glossy surface
高反光白板面

New Low Reflection whiteboard surface
全新低反光白板面

*Photo taken at The Mission Covenant Church Holm Glad No. 2 Primary School
基督教聖約教會堅樂第二小學 實境拍攝

Board Renewal 板面翻新

School Case 學校案例



*Photo taken at Chan's Creative School 啟基學校實境拍攝



*Photo taken at Fukien Secondary School (Siu Sai Wan) 福建中學(小西灣) 實境拍攝

Installation Steps 安裝步驟



Color Series 彩色系列

Small Colorboard 彩色小板

Light Weight Magnetic Colorboard 輕巧磁性彩色小板

Size range from A4 to A2, suitable for handheld or wall-mount use.
Each board includes a pen tray, magnetic eraser, whiteboard marker and hangers.
尺寸由A4至A2, 適合手提或掛牆使用。
每盒均附有筆盤、磁性白板刷、白板筆及掛板配件。



	Outer Size	Board Size
FP01N	225 x 300mm	203 x 278mm
FP1N	300 x 450mm	278 x 428mm
FP2N	450 x 600mm	428 x 578mm

	Outer Size	Board Size
FG01	225 x 300mm	203 x 278mm
FG1	300 x 450mm	278 x 428mm
FG2	450 x 600mm	428 x 578mm

Hexagon Magnetic Colorboard 六角形磁性彩色小板

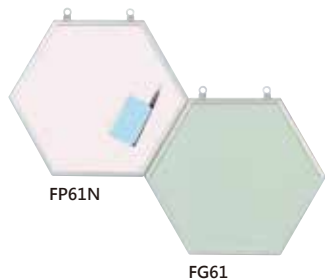

	Outer Size
FP61N	350 x 300mm
FG61	350 x 300mm

Wall-mount Magnetic Colorboard 掛牆式磁性彩色板



	Outer Size	Board Size
KPF23N	W910 x H610mm	W870 x H570mm
KPF34N	W1170 x H870mm	W1210 x H910mm
KPF36N	W1810 x H910mm	W1770 x H870mm

	Outer Size	Board Size
KFG23	W910 x H610mm	W870 x H570mm
KFG34	W1170 x H870mm	W1210 x H910mm
KFG36	W1810 x H910mm	W1770 x H870mm

Japan magnetic steel board color surface
日本鐵製磁性顏色板面

Accessories 附加產品

Whiteboard Marker (Black), 1pc
Eraser, 1pc
Hanger, 2pcs
Magnet, 4pcs



Board Color 表面顏色



Soft Pink
淡粉紅

Green
粉綠

RB series

RC series

Colorboard 彩色板



Extra Slim
特薄

Extra Safe
安全

Stylish
可自由組合

Model No. 型號	Size 尺寸
RB23 / RC23	600 × 900
RB34 / RC34	900 × 1200
RB36 / RC36	900 × 1800

Features

- Special installation design to ensure the board strongly fixed on the wall surface
- No exposed screw or sharp point after installation, safe for kids to use
- Mix andmatch your favorite frame and board color
- White/Color Board manufactured with special materials, board surface is 99.8% free from bacteria
- Frame is made of antibacterial ABS material

特點

- 專業設計的安裝方法，無須掛鉤，板面能穩固地緊貼牆壁，不會掉落
- 安裝後不會外露螺絲或尖角位，小朋友可安全安心地使用
- 讓您自由配搭板面及邊框顏色
- 板面由特別物料製造，99.8%抗菌，防菌性極佳
- 邊框採用抗菌樹脂製成



RB series

Super Slim!!

For experienced installation technician

超薄! 適合具經驗的安裝技術人員安裝

Frame Thickness 邊框厚度: 12mm

Board Color 板面顏色



White 白

Pink 粉紅

Green 綠

Frame Color 邊框顏色



Red
紅

Yellow
黃

Apple
Green
蘋果綠

Green
綠

Beige
淺褐

Ivory
象牙白

Blue
藍

Pink
粉紅



RC series

Easy Installation

簡易安裝

Frame Thickness 邊框厚度: 20mm

Board Color 板面顏色



White 白

Pink 粉紅

Green 綠

Frame Color 邊框顏色



Wood
木紋

Brown
啡

Pink
粉紅

Blue
藍

Ivory
象牙白

Installation 安裝

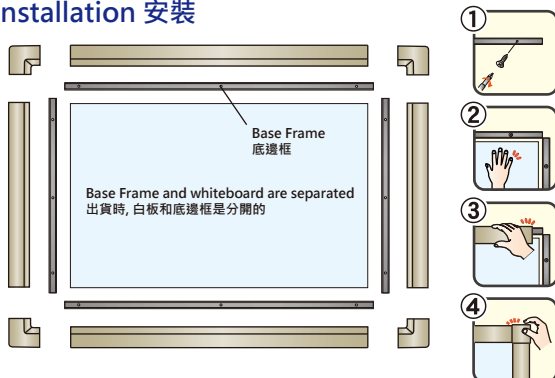

Installation 安裝

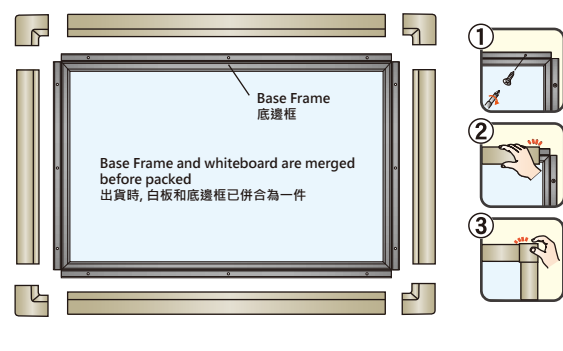

Color Combinations 配色組合

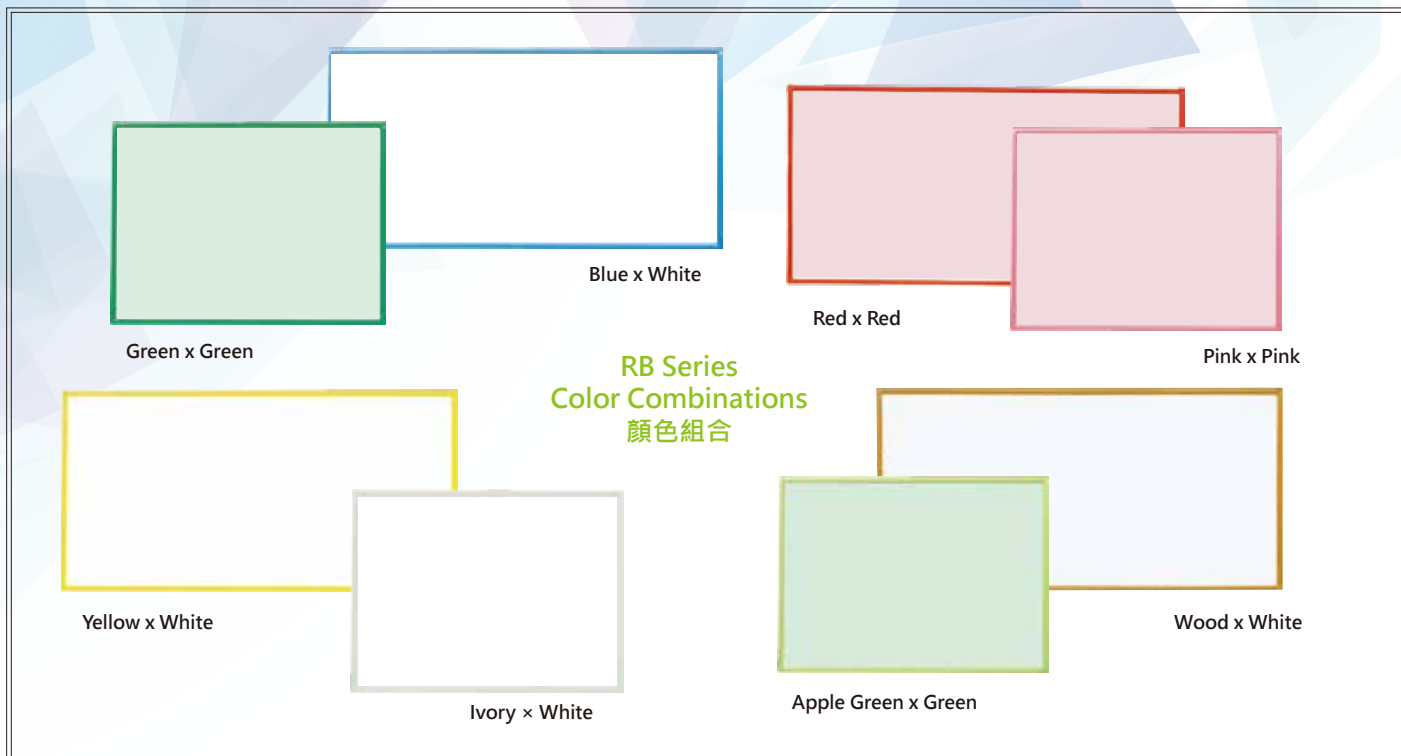

Applications 用途



★ 塗鴉創作，培養繪畫天份



★ 活動相架，時刻分享生活點滴



★ 併拼貼貼，啟發無限創意



★ 場景佈置，增添節日氣氛

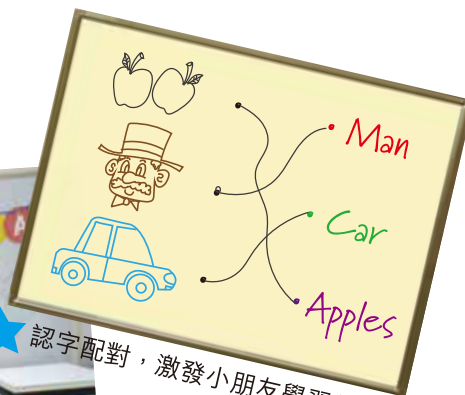

★ 認字配對，激發小朋友學習興趣

Mobile Whiteboard 活動白板

Suitable for kindergarten and kid's learning center. Design with reference to kid's height to let them draw freely, we wish to enrich their imaginations and for better learning experience.
適用於幼兒園及幼兒學習中心，參考小孩高度設計而成的活動白板，讓小孩能輕鬆於白板上書寫及塗鴉，從而建立他們的自信心，和盡情發揮他們的創意。

2-in-1 Double-sided Mobile Whiteboard for Kids 2-in-1 幼兒專用雙面活動白板組合

Outer size: W2440 x D557 x H1200
Board size: W1160 x H860
W1090 x H860



LB922N-G



LB922N-Y



LB922N-R

Features

- Double-side Porcelain Enamel Whiteboard (2pcs)
- Expandable up to 4 writing surfaces to let more kid's participate at the same time
- Round-safety corner design

特點

- 雙面搪瓷白板 x2塊，摺疊式設計，方便收藏又省位
- 可擴展至4個書寫面，讓更多小孩同時使用，增加彼此之間的互動性
- 安全圓角設計

Double-sided Mobile Whiteboard for Kids 幼兒專用雙面活動白板

Size 44
Outer size: W1836 x D550 x H1349
Board size: W1764 x H1180

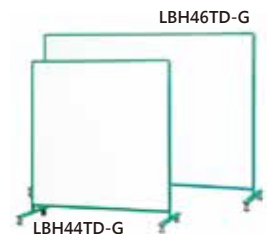

LBH44TD-G

Size 46
Outer size: W1236 x D550 x H1349
Board size: W1164 x H1180

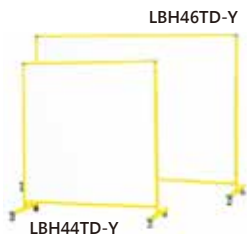

LBH44TD-Y



LBH46TD-R

Features

- Design according to kid's height
- Magnetic board surface
- Porcelain enamel whiteboard, excellent for writing
- Safety round corner design and robust mobile stand with lockable castors

特點

- 參考小孩高度設計
- 磁性板面
- 搪瓷白板，書寫順滑，抹擦效果極佳
- 圓角安全邊框及穩固的活動腳架 (附上鎖式滾輪)

Short Double-sided Porcelain Enamel Mobile Whiteboard / Greenboard (Total Height: 1.2m) 低位雙面活動搪瓷白板/綠板 (全高 1.2米)



Double-sided Greenboard
雙面綠板
MSL34TDN
MSL36TDN



One-side Greenboard/ One-side Enamel Whiteboard
一面綠板，一面搪瓷白板
MSHL34TDN
MSHL36TDN



Double-sided Enamel Whiteboard
雙面搪瓷白板
MHL34TDN
MHL36TDN

Size 34
Outer size: W1326 x D610 x H1200
Board size: W1170 x H870

Size 36
Outer size: W1926 x D610 x H1200
Board size: W1770 x H870

Transparent Board 透明板



No sight block in 360 degree,
enjoy safety playtime
360度無視線阻礙, 玩樂更安全

Creative new experience in
board learning & playing
可配合不同教材使用,
創出更多靈活新玩法

Special Coating for smooth
writing
特殊塗層加工,
讓書寫更清晰、更順滑

Frame Color
邊框顏色



KIDS
DESIGN
AWARD
2017

The Japan Kids Committee:
the product can allow greater
creativity and learning incentives
to kids
日本兒童協會推薦商品:
設計能給予小孩更大的創造性並有助
提昇學習趣味



Accessories 附加產品



Glassboard Eraser x 1pc
Glassboard markers (6-color) x 1 set
Multi-purpose Magnet Tape x 1pc

玻璃板刷 x 1個
玻璃板筆 (6色) x 1套
多用途磁石貼 x 1卷

Frame Color 架框顏色

Outer Size: W1254 x D550 x H962 Board Size: W1171 x H881

Silver 銀

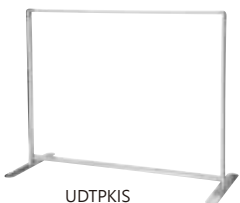

Red 紅

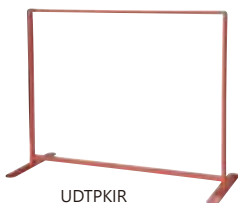

Green 綠

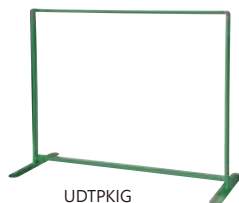

Yellow 黃

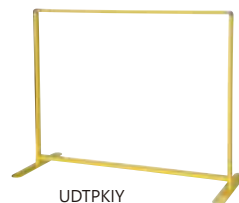

Black 黑

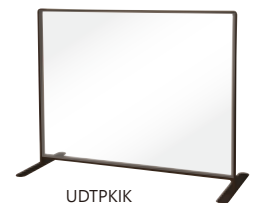

Features

- Transparent board design, you can see your kids while using.
- Clear Acrylic Board with special treatment for better writing experience with vivid marker color.
- Write and erase with the attached BGB Glassboard Markers to get the best performance.
- You can stick any kind of teaching materials at the back of the board and write on the front surface.
- Magnetic board surface.
- Design according to kid's height.
- Safety round corner design and stable mobile stand with lockable castors

特點

- 透明設計, 可以清楚看到他們使用時的樣子
- 有機玻璃面上的特殊圖層加工, 令書寫更清晰鮮明
- 使用隨板附送的BGB玻璃白板筆達到最佳的書寫及抹擦效果
- 透明板面, 可張貼教材在板後, 並在前面書寫
- 可使用隨板附送的多用途磁石貼張貼展示物
- 專為小孩高度設計
- 圓角安全邊框及穩固的活動腳架(附上鎖式滾輪)

CCchalk

calcium carbonate chalk



High Density Dustless Chalk 高密度無塵粉筆

- Made of Calcium Carbonate
- Writing distance up to 600-750 meters per pc
- Non-toxic, safe for human use
- CE certified product
- Green Purchase Network product
- Brilliant and Vivid color
- Each box 72pcs (packed in 6 Inner boxes, with 12pcs per inner box)

- 碳酸鈣製，耗粉量低
- 每支可書寫約 650 ~ 700米 !!
- 成份對人體無害，安全安心使用
- CE認證，符合歐洲標準
- 符合綠色環保購入法基準商品
- 色彩亮麗鮮明
- 盒內再分6小盒，方便補充



Model No 型號
MCC501 White 白

Packing 包裝
72 pcs per box / 24 boxes per carton
每盒 72支 / 每箱24盒



Model No 型號
MCC502 Color 彩色
(Red, Blue, Yellow,
Green, Brown and Pink)
(紅, 藍, 黃, 綠, 啡及粉紅)

Packing 包裝
72 pcs per box / 24 boxes per carton
每盒 72支 / 每箱24盒

CCA-S Chalk Carving Set CCA-S 石膏粉筆雕刻套裝

It is fun and simple to make chalk carving!
This package includes:

1. UMAJIRUSHI Jumbo Chalk, 1box (3pcs)
2. Carving tool, 1pc
3. Diamond Rhinestone, 1 pack

簡簡單單,自己動手做雕刻! 日本材料,安全安心!
套裝包括

1. 日本馬印白色極太粉筆乙盒(3支)
2. 雕刻工具乙支
3. 手工閃石乙包



School Chalk 學校粉筆 (100pcs)



C206 Green / C203 Red / C201 White /
C207 Brown / C204 Blue / C205 Yellow /
C202 5-Color

School Chalk 學校粉筆 (10pcs)



C310 4-color / C311 White / C313 Red / C314 Blue / C315 Yellow / C316 Green / C317 Brown

Jumbo Chalk 極太粉筆 (25pcs)

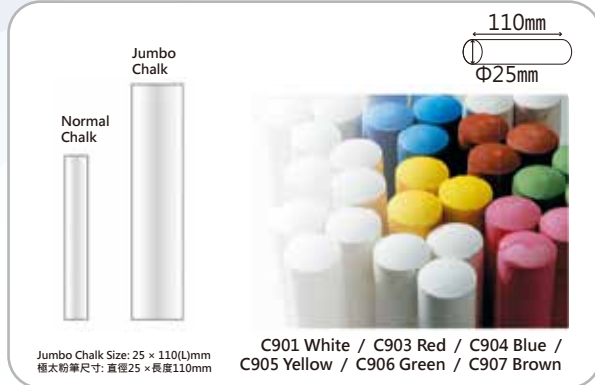

Jumbo Chalk Size: 25 x 110(L)mm
極太粉筆尺寸: 直徑25 x 長度110mm

C901 White / C903 Red / C904 Blue /
C905 Yellow / C906 Green / C907 Brown

Jumbo Chalk 極太粉筆 (3pcs)



C391 White / C393 Red / C394 Blue / C395 Yellow / C396 Green / C397 Brown

Weather-proof Chalk 全天候雨天粉筆



C801 White / C802 5-color / C803 Red / C804 Blue / C805 Yellow / C806 Green

Magnetic Chalk Holder With Cap 磁性粉筆套連筆蓋



CH 400

2-in-1 Eraser Box 二合一粉筆連粉擦

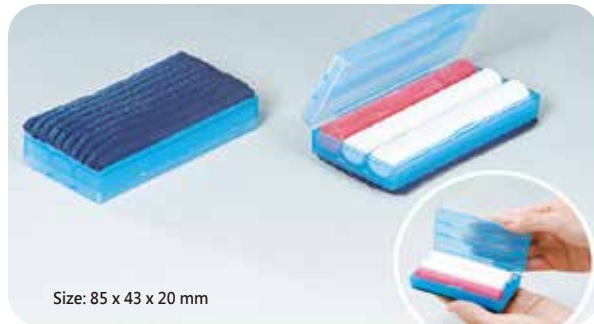

Size: 85 x 43 x 20 mm



Eraser 板刷

Features

- Extra large erasing surface to minimize the erasing times and reduce the tiresome from continuous movement of arm
- Thick velour surface to ensure high durability
- Easy to hold with hand band design (apply to large size)
- Single-side to avoid direct contact of hand to the chalk powder

特點

- 特大接觸面・減少來回拭擦的次數・同時減輕手部因頻密拭擦而產生的疲勞
- 特厚絨面讓黑板擦更耐用
- 設手帶設計・方便省力
- 單面設計・避免雙手直接接觸粉末

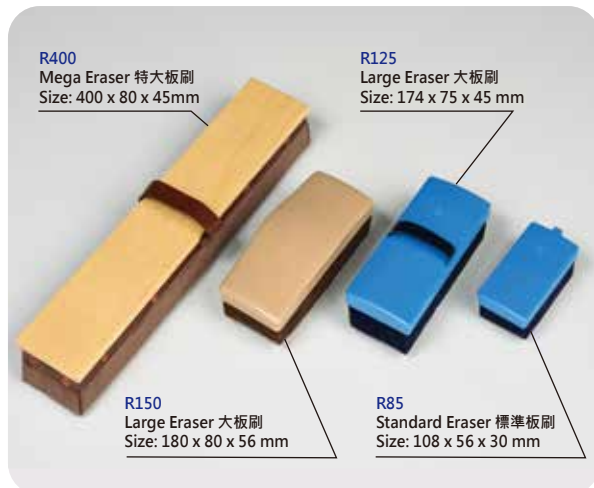

R400
Mega Eraser 特大板刷
Size: 400 x 80 x 45mm

R125
Large Eraser 大板刷
Size: 174 x 75 x 45mm

R150
Large Eraser 大板刷
Size: 180 x 80 x 56mm

R85
Standard Eraser 標準板刷
Size: 108 x 56 x 30mm

POP GEL CHALK 多用途粉筆



Model No 型號	Color 顏色
BPG-W	White 白
BPG-P	Pink 粉紅
BPG-R	Red 紅
BPG-D	Orange 橙
BPG-Y	Yellow 黃
BPG-B	Blue 藍
BPG-G	Green 綠
BPG-K	Black 黑
BPG-8PS	8-Color Set 8色套裝

Suitable for 適用於



Blackboard 黑板



Glass 玻璃



Whiteboard 白板



Drawing Paper 畫紙

Features 特性



4mm bold strokes
To let you create attractive fonts with vivid effect.

特闊4mm線幅
配合不同角度寫出粗幼有致的效果,讓文字變得更加立體。

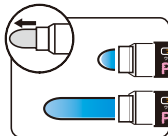

Retractable mechanism

Allows you to use the chalk till the last drop and protects the chalk from break when it is not in used.

伸縮性筆嘴

書寫時更乾淨企理,伸縮性筆嘴讓您輕鬆了解使用情況,當不使用時可將筆芯收入筆筒內,減低斷掉的機會。

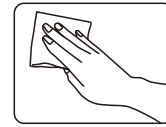

Easy to clean

Wipe with wet cloth, no marks will be left on board.

清潔容易

用濕布拭擦,絕不留痕,亦不損書寫表面。

Glassboard Marker 玻璃板筆



Suitable for writing on Transparent Board, Whiteboard, Glossy Blackboard and Glass surface.
適用於透明板、白板、光面黑板及玻璃等表面。

Transparent Board 透明板

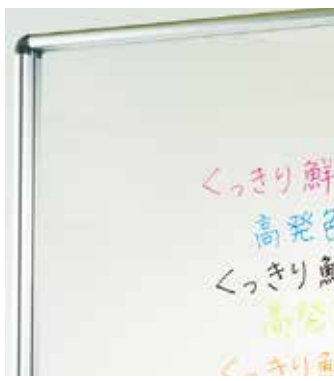

Glossy Blackboard 光面黑板



Model No 型號	Color 顏色
BGB-W	White 白
BGB-P	Pink 粉紅
BGB-D	Orange 橙
BGB-Y	Yellow 黃
BGB-B	Blue 藍
BGB-K	Black 黑
BGB-6PS	6-Color Set 6色套裝



R608-P
Transparent Board Eraser
透明板刷



R608-SP
Transparent Board Eraser
Refill (3pcs)
透明板刷替換布 (3片)

Whiteboard Accessories 白板配件

Whiteboard Marker 白板筆

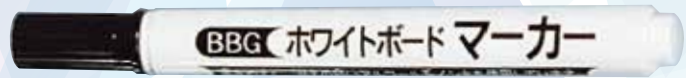

BBG-K
Black 黑



BBG-R
Red 紅



BBG-B
Blue 藍



BBG-G
Green 綠

Whiteboard Eraser 白板刷



R508P
Complete Sponge
Whiteboard Eraser
全效型海绵白板刷
Size: 150(L) x 58(W) x 42(H) mm



R508S-2P
Complete Sponge
Whiteboard Eraser (Refill)
全效型海绵白板刷 (替芯)
Size: 150(L) x 50(W) x 40(H) mm



R150N
Size: 180(L) x 80(W) x 40(H)mm



R150SP (5pcs)



R188N
Size: 135(L) x 58(W) x 35(H)mm



R188SP (5pcs)



R88N
Size: 110(L) x 52(W) x 28(H)mm



R88SP (5pcs)



R108
Size: 100(L) x 55(W) x 29(H)mm



R108SP (5pcs)



R98N
Size: 67(L) x 25(W) x 89(H)mm

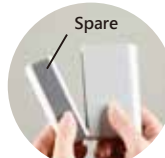

R98NK

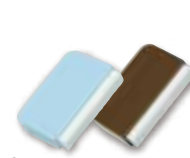

R48
Size: 84(L) x 60(W) x 16(H)mm



R48K

筆
Brush touch
夕
子



Chinese Calligraphy Brush Set
白板専用書法套裝
BFT-S10



Whiteboard use writing brush
専用毛筆
BFT-FUP



Whiteboard ink(Black)
専用墨水(黒)
BFT-IN10
100ml



Whiteboard ink(Red)
専用墨水(紅)
BFT-IN-S
100ml



Palette
墨水碟
BFT-PLG



Whiteboard Accessories 白板配件



Multi Purpose Magnetic Tape 19mm x 3M 多用途磁石貼19毫米x3米

Standard Colors 基本7色系列



CMT-B
Neon Blue
螢光藍

CMT-PU
Neon Purple
螢光紫

CMT-Y
Neon Yellow
螢光黃

CMT-G
Neon Green
螢光綠

CMT-P
Neon Pink
螢光粉紅

CMT-S
Neon Silver
銀

CMT-K
Neon Black
黑

Usage 用途：

Post documents, photos, cards, posters and teaching materials for display.
張貼文件、相片、卡片、海報、教材等作展示用途。



Refrigerator
雪櫃



Iron
鐵面



Whiteboard
白板



Stationery
文具



Glass
玻璃



Shop
店舖



Curtain
窗簾



Plastic
塑膠



Working Space 工作間



Window 窗戶



For children's artwork 兒童作品

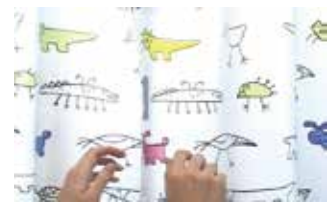

As a magnetic buckle 磁力門扣

Magnetic Pen Tray 磁性筆盤

ABS safety stopper in both ends
兩側均為樹脂保護角



【 L = 548mm 】

UTR600

Dimension 尺寸 / W548×D42×H35
Weight 重量 / 275g

【 L = 848mm 】

UTR900

Dimension 尺寸 / W848×D42×H35
Weight 重量 / 420g



【 L = 548mm 】

UTR600-K

Dimension 尺寸 / W548×D42×H35
Weight 重量 / 275g

【 L = 848mm 】

UTR900-K

Dimension 尺寸 / W848×D42×H35
Weight 重量 / 420g

Retractable Pointer 伸縮指揮棒

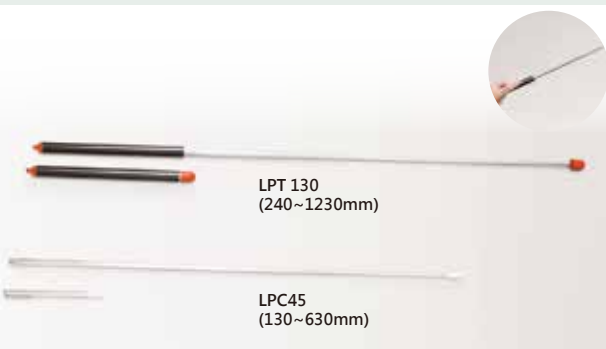

LPT 130
(240~1230mm)

LPC45
(130~630mm)

Strong Round Magnet (30mm dia)

磁氣250 強力圓形磁石 (30mm 直徑)

8 pcs per pack 8粒裝



Model No	Color
CMZ30-W	White 白
CMZ30-R	Red 紅
CMZ30-B	Blue 藍
CMZ30-Y	Yellow 黃
CMZ30-G	Green 綠
CMZ30-K	Black 黑
CMZ30-D	Orange 橙

Customized Case 訂製案例

The well-known Japanese brand UMAJIRUSHI whiteboards are not limited to conventional product installations.

Over the past few years, we have been customizing different styles and sizes based on the specific needs of our customers and the constraints of their environments. This allows our products to seamlessly integrate into the required venues, both in terms of functionality and visual aesthetics, becoming an integral part of the overall space design.

大家認識的日本馬印白板, 其實並不只限於常規產品的安裝。過去多年, 我們都會按客戶不同的需要和環境上的限制, 訂製不同款式和尺寸, 讓產品無論在使用上和視覺上都能融入場地所需, 成為場地設計的一部份。

Vertical Whiteboard Panels with hidden door 併合式白板牆連暗門



Size: 18000(W) x 3100(H) mm

Photo taken at The Chinese University of Hong Kong

香港中文大學 實景拍攝

The total length of the whiteboard wall is about 18 meters, made up of 15 whiteboard modules, 5 of them are built with push-button hidden doors, which are convenient for customers to use for fire equipment maintenance or electrical inspection in the future.

Customized pure white aluminium frame achieves frameless effect when viewed from the front, it is well-arranged to form a giant whiteboard wall. Each whiteboard panel is lightweighted but hard and durable, will not be deformed even for long-term use.

白板牆全長約18米, 由15塊白板模組併合而成, 當中5塊是特製按彈式暗門, 方便客戶日後進行消防設備維修或電力檢查時之用。特製純白鋁邊框和骨架, 從正面看能做到無邊框的效果, 美觀大方, 而且非常輕巧, 即使長期使用亦不會變形。

Free Standing Whiteboard Wall 自立式白板牆



Size: 6000(W) x 3100(H) mm

The first self-supporting whiteboard wall in Hong Kong with a height of 3100cm (H) x 6M (L). The uniqueness of this product lies in the fact that the whiteboard wall does not need to be attached to the wall, it is made up of 5 whiteboard panels with a height of 3.1m, the product is surrounded by white aluminium frames to strengthen the structure of the whiteboards and make the product look rigid and safety.

全港首套能做到3100cm (高) x 6M (長) 的自立式白板牆，產品獨特之處在於白板牆無須依附在牆身，由5塊高3.1米的整幅白板組合而成，配以白色鋁合金邊框圍邊，鞏固白板結構，讓產品達至美觀和安全的效果。

Large Seamless Projection Whiteboard 大型無縫投影白板



Size: 9050(W) x 1508(H)mm

On-site roll-up installation, professional design can achieve seamless, no interface effect, large projection board surface can be used with multiple projectors at the same time.

Special whiteboard surface can effectively minimize the projection reflection, and remove the so-called "Aperture", while the projected image with a gain effect, the first Virtual Classroom in Asia use the same whiteboard model. Images and writings can be clearly seen via video cam.

現場卷裝式安裝，專業的設計能做到無縫、無接口效果，特長的投影板面，能同一時間配合多部投影機使用。

白板獨特的磨沙板面，能有效地將投射反光減到最低，並去除所謂的「光圈」，同時能對投射的映像帶有增益效果，亞洲首個虛擬課室，也是採用同型號的白板，透過視像仍能清楚看到白板上的映像和文字。

Frameless Non-reflective Soft Whiteboard Wall 無邊框不反光軟白板牆



Size: 4880(W) x 2200(H)mm

Photo taken at The Education University of Hong Kong Jockey Club Primary School

香港教育大學賽馬會小學 實景拍攝

Due to the limitation of the site environment, we used UMAJIRUSHI whiteboard sheet to build a borderless writing wall to client, suitable for both writing and projection use, the surface of the whiteboard sheet is magnetic, the advantages of this formula are relatively low cost, easy to install, and can be replaced at any time if there is any damage in the future.

因場地環境限制，本次工程我們採用了日本馬印白板貼來打造無邊框的書寫牆，適合書寫和投影兩用，白板貼表面有磁力，優點是成本相對低，容易安裝，日後若有損壞也可隨時更換。

Vertical Sliding Board Combo 上下升降組合板



Size: 7380(W) x 1860(H)mm, composed with 3 sets of vertical sliding board

The unique feature of UMAJIRUSHI vertical sliding board combo is that the board can stop at any point along the track. There are 2 models: wall-mounted and free-standing, customers can enjoy a doubled writing space in the limited space, suitable for the use of high ground floor places.

馬印上下升降板能在軌道上任何一點停下，產品分掛牆式和柱立式兩款，讓客戶能在有限的空間內將書寫空間增加一倍，板面可選擇常規搪瓷白板或投影搪瓷白板，適合樓底高的地方使用。

Curved Enamel Whiteboard 曲面搪瓷白板



Size: 3600(W) x 1200(H) mm

Photo taken at Learning Garden, Library, The Chinese University of Hong Kong

中文大學 圖書館 進學園 實景拍攝

In addition to flat whiteboards, UMAJIRUSHI can also customize curved whiteboards to meet the needs of on-site environments.

馬印除了平面的白板外，亦可按客戶需要訂製曲面白板，以附合現場環境需要。

2 in 1 Sliding Board 左右趟門組合白板



In this project, there is an electronic whiteboard on the wall, client requests for a set of door combination in front of the TV, when the TV is idle it can be hidden behind the doors. UMAJIRUSHI designed to use our Enamel whiteboard as the door instead of traditional wooden door so that client can do writing any time. We have designed a set of specialized tracks and rollers for this, even if the board weighs 50kgs, user can move smoothly along the track, and will not fall due to long time movement, safe and beautiful.

本次項目的場地牆身已有一台電子白板，按客戶要求在電視前增設一套趟門組合，當電視不使用時能用將電視隱藏起來，趟門並非採用傳統の木門，而是改為馬印的搪瓷白板，方便書寫。馬印為此設計了一套專門的趟門路軌和滾輪，即使板重 50kgs 仍能暢順移動，並且不會因長時間移動而掉落，安全美觀。

Why UMA-JIRUSHI Porcelain Enamel Whiteboard? 為何選擇日本馬印搪瓷板?

符合環保規格 Environmental Friendly



UMA-JIRUSHI products are made of non-formaldehyde and decomposable materials which is harmless to our Earth. UMA-JIRUSHI is member of GPN (Green Purchase Network). GPN is a large network organization, which encourage consumer to buy quality environmental products.

馬印產品使用非甲醛釋放的材料製作,減低環境的破壞。並採用可被分解的材料以推動資源再用的目標。株式會社馬印更是GPN的會員。GPN於日本擁有龐大的網路,以提倡優質購買環保產品為組織的宗旨。

Quality Assurance 搪瓷白板優質保證

Durable and Long-lasting! UMA-JIRUSHI Enamel whiteboard surface is 2-4 times harder than the boards available in the market
馬印搪瓷板比其他市面上的產品厚2-4倍,更耐用、更持久。

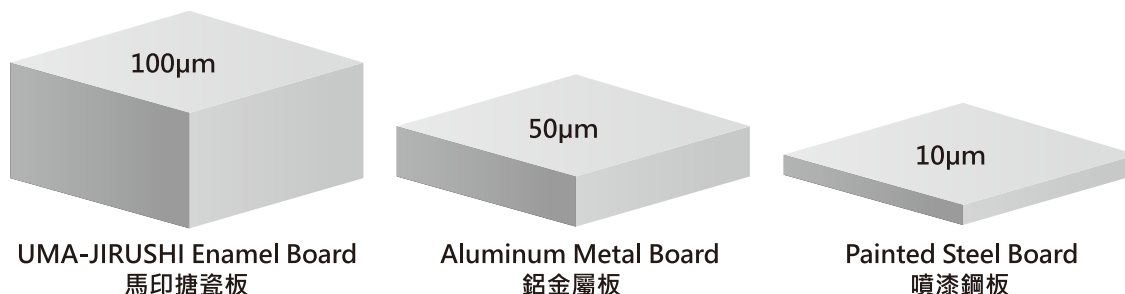

Tested Mineral 測試物質	Talc 滑石	Gypsum 石膏	Calcite 方解石	Fluorite 螢石	Apatite 磷灰石	Feldspar 長石	Quartz 水晶	Topaz 黃玉	Corundum 剛玉	Diamond 鑽石
Hardness 堅硬度	1	2	3	4	5	6	7	8	9	10
UMA-JIRUSHI Enamel Board 馬印搪瓷板	5.5 ~ 8.5									
Aluminum Metal Board 鋁金屬板	3.5									
Painted Steel Board 噴漆鋼板	2.5									

Pass with Mohs Hardness Test, UMA-JIRUSHI is proved to be 2 times harder than other boards.
經過摩氏硬度測試,馬印板的堅硬度比其他板高出兩倍。

